

TECHNICAL CHARACTERISTICS

		STANDARD	AVAILABLE OPTIONS
Technology		Peristaltic	
Maximum Flow rate at 1 cSt L/h (GPM)		26000 (114.47) (1)	
Ports		ISO PN16 flanges	ISO PN20 / ANSI150 flanges
Dimensions mm (in.)	A	1160 (45.67)	
	B	1042 (41.02)	
	C	746 (29.37)	
	D	157 (6.18)	
	E	1073 (42.24)	
Weight kg (lbs)		575 (1268)	

(1) Intermittent duty only.

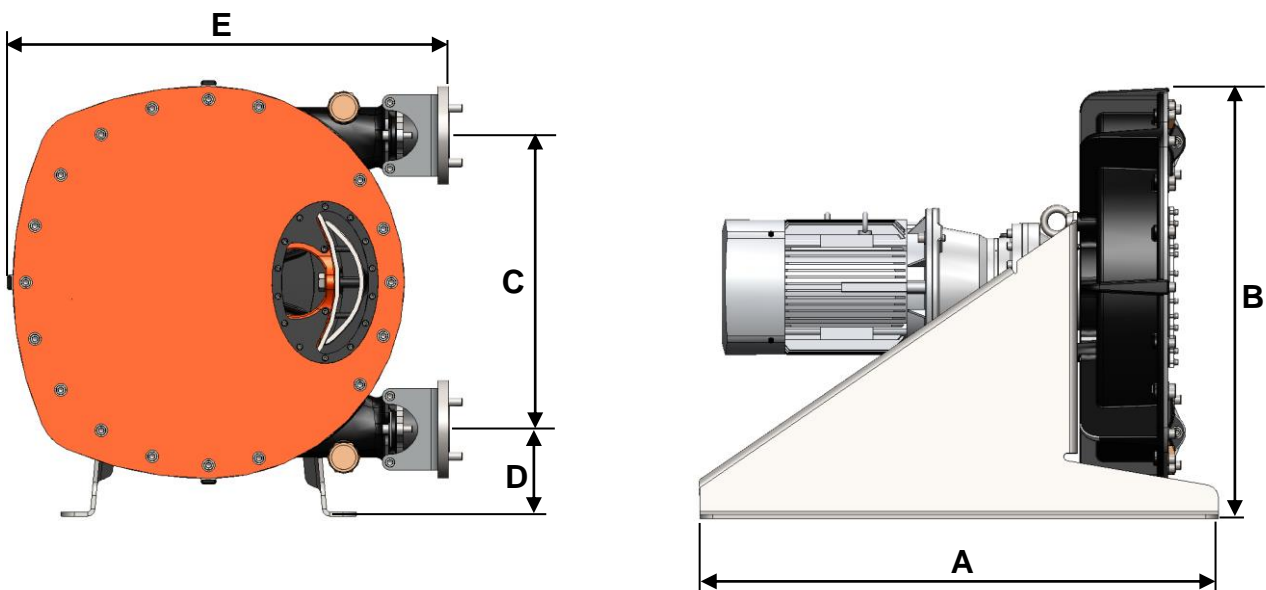

OPERATING LIMITS

	STANDARD MATERIALS	OPTIONAL MATERIALS
Minimum temperature °C (°F)	0 (32)	
Maximum temperature °C (°F)	70 (158)	80 (176) with EPDM hose
Maximum viscosity cSt (SSU)	30000 (140000)	
Maximum differential pressure bar (psi)	15 (217)	
Maximum speed rpm	65 (1)	
Maximum solid particle size mm (in)	10 (0.39)	
Maximum soft particle size mm (in)	16 (0.63)	

(1) Intermittent duty only.

MATERIALS OF CONSTRUCTION

Part No	PART NAME	STANDARD MATERIALS	AVAILABLE OPTIONS
1	Body	Ductile Iron	
2	Cover	Carbon steel	
3	Rotor	Ductile Iron	
5	Shoe	Ductile Iron	
10	Cover seal	NBR	
26	Shaft seal	NBR	
12	Insert	316L Stainless steel	PPH, PVDF
16	Hose	NR	NBR, NBR-FDA, EPDM, Hypalon
18	Bracket	Zinc plated steel	
21	Frame	Zinc plated steel	
	Bolts, screws, washers	Zinc plated steel	
25	Window	Polycarbonate	

