

FLEX-PRO[®]

Peristaltic Metering Pump

PROSERIES-M[®]

M-3 and M-4

Operating and Maintenance Manual



Exclusive:



Patent No. 7,001,153 & 7,284,964



ProSeries[®]

by Blue-White Ind.

Protected by Patents: 8,215,931;
7,001,153; 7,284,964; 4,496,295
and other patents pending

5300 Business Drive, Huntington Beach, CA 92649 USA

Phone: 714-893-8529 FAX: 714-894-9492

E mail: sales@blue-white.com or techsupport@blue-white.com URL: www.Blue-White.com

TABLE OF CONTENTS

<u>Section</u>	<u>Heading</u>	<u>Page</u>
1.0	Introduction	2
1.1	Available Models	3
1.2	Specifications	4
1.3	Materials of Construction	4
1.4	Features	5
1.5	Agency Listings	5
2.0	Installation	6
2.1	Mounting Location	6
2.2	Mounting Dimensions.	7
2.3	Input Power Connections	8
2.4	Wiring Terminals and I/O Schematics	9
3.0	How to Operate Flex-Pro.	10
3.1	Menu Navigation	11
3.2	Configuration Menu	12
3.2.1	Language Selection	12
3.2.2	Display Rate (units of measure)	13
3.2.3	Reset Factory Defaults.	13
4.0	Input Setup.	14
4.1	Max RPM cut-off	15
4.2	Max Flowrate (Output Calibration)	15
4.3	Input Setup (Operating Mode Configuration)	16
4.3.1	Manual Adjust (manual speed adjust)	16
4.3.2	4 - 20 mA Input	17
4.3.3	0 - 10 VDC Input	18
4.3.4	Frequency Input (Hz)	19
4.3.5	Pulse Batch (low speed batch)	20
4.3.6	Manual Cycle Adjust (repeating cycle timer).	21
4.3.7	Dispensing	22
4.3.8	Manual Dosing	23
4.3.9	Proportional Dosing	24
4.4	Contact Closure Input (Remote start/stop).	25
4.5	Set FVS (Flow Verification System).	26
4.6	TFD (Tube Failure Detection)	27
4.6.1	TFD Adjustment.	27
4.7	Remote/Local Control.	28
4.8	Set Revolution Counter	28
5.0	Output Setup (Alarm Relays & Output Signal signals)	29
5.1	Signal Output	30
6.0	Pump Maintenance.	31
6.1	Routine Inspection and Maintenance.	31
6.2	How to Clean and Lubricate the Pump	31
6.3	Reverse Rotor Rotation	31
6.4	Tube Replacement.	32
6.5	Replacement Parts List	34
7.0	Tubing Data	36
7.1	Output Versus Fluid Viscosity	36

1.0 Introduction

Congratulations on purchasing the Flex-Pro variable speed Peristaltic Metering Pump.

Your Flex-Pro pump is pre-configured for the tubing that shipped with your metering pump. The tubing assembly has an Identification number printed for easy re-order.

Please Note: Your new pump has been pressure tested at the factory with clean water before shipping. You may notice trace amounts of clean water in the pre-installed tube assembly. This is part of our stringent quality assurance program at Blue-White Industries.

1.1 Available Models

Output Range			Max Speed	Max Pressure	Max Temperature	M-3	Model Numbers		
Flex-A-Prene® M-3 Tube Pumps									
Listed under NSF Std. 61 Meets FDA criteria for food Excellent chemical resistance CIP SIP									
GPH	LPH	ML/MIN	RPM	PSI (bar)	F (C)	115V AC	230V AC	220V AC	
.0002 - 2.10	.0007 - 7.92	.0132 - 132	125	125 (8.6)	185 (85)	M-324-*ND	M-325-*ND	M-326-*ND	
.0025 - 25.3	.0096 - 96.0	.1596 - 1596	125	125 (8.6)	185 (85)	M-324-*NJ	M-325-*NJ	M-326-*NJ	
.0033 - 33.3	.0126 - 126	.2100 - 2100	125	125 (8.6)	185 (85)	M-324-*NK	M-325-*NK	M-326-*NK	
.0033 - 33.3	.0126 - 126	.2100 - 2100	125	30 (2.1)	185 (85)	M-324-*NKL	M-325-*NKL	M-326-*NKL	
Flex-A-Prene® M-3 Tube Pumps									
Listed under NSF Std. 61 Meets FDA criteria for food Excellent chemical resistance Extra long life at low pressures									
GPH	LPH	ML/MIN	RPM	PSI (bar)	F (C)	115V AC	230V AC	220V AC	
.0004 - 4.76	.0018 - 18.0	.03 - 300	125	110 (7.6)	185 (85)	M-324-*NEE	M-325-*NEE	M-326-*NEE	
.0019 - 19.02	.0072 - 72.0	.12 - 1200	125	110 (7.6)	185 (85)	M-324-*NGG	M-325-*NGG	M-326-*NGG	
Flex-A-Chem® M-3 Tube Pumps									
Listed under NSF Std. 61 Meets FDA criteria for food Superior chemical resistance									
GPH	LPH	ML/MIN	RPM	PSI (bar)	F (C)	115V AC	230V AC	220V AC	
.0015 - 15.06	.0057 - 57.0	.0950 - 950	125	50 (3.4)	130 (54)	M-324-*TH	M-325-*TH	M-326-*TH	
.0028 - 28.5	.0108 - 108	.18 - 1800	125	50 (3.4)	130 (54)	M-324-*TK	M-325-*TK	M-326-*TK	
Flex-A-Thane® M-3 Tube Pumps									
Meets FDA criteria for food Resistant to oils, greases and fuels									
GPH	LPH	ML/MIN	RPM	PSI (bar)	F (C)	115V AC	230V AC	220V AC	
.0004 - 4.60	.0017 - 17.4	.0290 - 290	125	65 (4.5)	130 (54)	M-324-*GE	M-325-*GE	M-326-*GE	
.0010 - 10.1	.0038 - 38.4	.0637 - 637	125	65 (4.5)	130 (54)	M-324-*GG	M-325-*GG	M-326-*GG	
.0024 - 24.9	.0094 - 94.2	.1570 - 1570	125	65 (4.5)	130 (54)	M-324-*GH	M-325-*GH	M-326-*GH	
.0028 - 28.5	.0108 - 108	.1800 - 1800	125	65 (4.5)	130 (54)	M-324-*GK	M-325-*GK	M-326-*GK	
.002 - 18.23	.007 - 69.0	.115 - 1150	125	65 (4.5)	130 (54)	M-324-*G2G	M-325-*G2G	M-326-*G2G	
Output Range			Max Speed	Max Pressure	Max Temperature	M-4	Model Numbers		
Flex-A-Prene® M-4 Tube Pumps									
Listed under NSF Std. 61 Meets FDA criteria for food Excellent chemical resistance CIP SIP									
GPH	LPH	ML/MIN	RPM	PSI (bar)	F (C)	115V AC	230V AC	220V AC	
.0028 - 28.5	.0108 - 108	.180 - 1800	125	125 (8.6)	185 (85)	M-424-*NH	M-425-*NH	M-426-*NH	
.0044 - 44.4	.0168 - 168	.280 - 2800	125	100 (6.9)	185 (85)	M-424-*NJ	M-425-*NJ	M-426-*NJ	
.0054 - 54.4	.0204 - 204	.3400 - 3400	125	65 (4.5)	185 (85)	M-424-*NHHH	M-425-*NHHH	M-426-*NHHH	
.0050 - 50.7	.0192 - 192	.320 - 3200	125	80 (5.5)	185 (85)	M-424-*NK	M-425-*NK	M-426-*NK	
.0054 - 54.0	.0204 - 204	.340 - 3400	125	100 (6.9)	185 (85)	M-424-*NHH	M-425-*NHH	M-426-*NHH	
.010 - 100.0	.0378 - 378	.630 - 6300	125	50 (3.4)	185 (85)	M-424-*NL	M-425-*NL	M-426-*NL	
.015 - 158.5	.0600 - 600	1.00 - 10000	125	30 (2.1)	185 (85)	M-424-*NP**	M-425-*NP**	M-426-*NP**	
Flex-A-Chem® M-4 Tube Pumps									
Listed under NSF Std. 61 Meets FDA criteria for food Superior chemical resistance									
GPH	LPH	ML/MIN	RPM	PSI (bar)	F (C)	115V AC	230V AC	220V AC	
.0054 - 54.00	.0204 - 204	.3400 - 3400	125	30 (2.1)	130 (54)	M-424-*TK	M-425-*TK	M-426-*TK	
.0126 - 126.0	.0477 - 477.0	.800 - 8000	125	30 (2.1)	130 (54)	M-424-*TKK	M-425-*TKK	M-426-*TKK	
Flex-A-Thane® M-4 Tube Pumps									
Meets FDA criteria for food Resistant to oils, greases and fuels									
GPH	LPH	ML/MIN	RPM	PSI (bar)	F (C)	115V AC	230V AC	220V AC	
.0039 - 39.6	.0150 - 150	.250 - 2500	125	65 (4.5)	130 (54)	M-424-*GH	M-425-*GH	M-426-*GH	
.0055 - 55.5	.0210 - 210	.350 - 3500	125	65 (4.5)	130 (54)	M-424-*GK	M-425-*GK	M-426-*GK	
.010 - 100.0	.0378 - 378	.630 - 6300	125	65 (4.5)	130 (54)	M-424-*GKK	M-425-*GKK	M-426-*GKK	

- The Flex-Pro Pump's motor speed is linear over the entire 0.05% to 100% adjustment range.
- Output versus pressure is nearly linear in all models. Larger tubes exhibit greater losses.
- See the instruction manual for output versus viscosity curves.
- For optimum tube life, specify the pump to operate at the lowest possible RPM and pressure.
- Output based on testing with water at 72 F, 5 foot suction lift, atmospheric conditions at sea level.

- * Inlet/outlet connection type.
- ** NP flow rate reduced 16.5% with Quick Disconnect connections.
- S = 3/8" OD x 1/4" ID tubing compression type connections (M-3 models only)
- M = 1/2" male NPT (available on M-3 & M-4 models)
- B = 1/2" ID tubing barb type conn. (ND, NKL, NEE, NGG, G2G and M-4 models only)
- C = 1/2" - 3/4" tri-clamp (Sanitary Fitting) connections (ND, NKL, NEE, G2G, and NGG only)
- Q = Quick Disconnect (M-3 Models ND, NKL, NEE, NGG, G2G, and M-4 single Flex-A-Prene® tube models only)
- (Valves sold separately)

1.2 Specifications

Maximum working pressure (excluding pump tubes):

125 psig (8.6 bar)

Note: see individual pump tube assembly maximum pressure ratings.

Maximum Fluid temperature (excluding pump tubes):

185° F (85° C)

Note: see individual pump tube assembly maximum temperature ratings.

Ambient Operating Temperature

14°F to 115°F (-10°C to 46°C)

Ambient Storage Temperature

-40°F to 158°F (-40°C to 70°C)

Operating Voltage:

M-3 MODELS:

115VAC/60Hz, 1ph (2.0 Amp Maximum)

230VAC/60Hz, 1ph (1.0 Amp Maximum)

220VAC/50Hz, 1ph (1.0 Amp Maximum)

240VAC/50Hz, 1ph (1.0 Amp Maximum)

M-4 MODELS:

115VAC/60Hz, 1ph (3.1 Amp Maximum)

230VAC/60Hz, 1ph (1.6 Amp Maximum)

220VAC/50Hz, 1ph (1.6 Amp Maximum)

240VAC/50Hz, 1ph (1.6 Amp Maximum)

Power Cord Options:

115V60Hz = NEMA 5/15 (USA)

230V60Hz = NEMA 6/15 (USA)

220V50Hz = CEE 7/VII (EU)

240V50Hz = AS 3112 (Australia/New Zealand)

Enclosure:

NEMA 4X (IP66), Polyester powder coated aluminum.

Maximum Overall Dimensions:

M-3 models: 8-1/8"W x 10-3/4"H x 15-1/4"D (20.6W x 27.3H x 38.9D cm)

M-4 models: 12-1/8"W x 14-1/4"H x 18-5/8"D (30.8W x 36.1H x 47.3D cm)

1.3 Materials of Construction

Wetted components:

Pump Tube Assembly (Model Specific - 2 provided):

Tubing: Flex-A-Prene® or Flex-A-Chem® Flex-A-Thane®

Adapter fittings: .PVDF

Recommended Ancillary Items Sold Separately:

Injection / Back-flow Check valve:

Body & insert: PVDF

Check Ball: Ceramic

Spring: Hastelloy C-276

Ball Seat O-ring: TFE/P (optional EP)

Static Seal O-ring: TFE/P (optional EP)

For "S" tubing type connections only:

(Available on M3 only)

Suction Tubing: 3/8" OD x 1/4" ID x 10' Clear PVC

Discharge Tubing: 3/8" OD x 1/4" ID x 10' Polyethylene (LLDPE)

Suction Strainer: PVDF

For "B" barb tubing and "M" M/NPT connections only:

(Available on ND, NKL, NGG, NEE, G2G, and M-4 only)

Suction Strainer:

Body: PVDF

Check Ball: Ceramic

Ball Seat O-ring: TFE/P (optional EP)

For "C" Tri-clamp and "Q" Quick Disconnect connections* only:

(Available on ND, NKL, NGG, G2G, and NEE only)

Suction Strainer: PVDF

*Quick Disconnect Valves sold separately

Approximate shipping wt:

M-3 models: 33 lb. (15.0 Kg)

M-4 models: 58 lb. (26.3 Kg)

Motor speed adjustment range

10,000:1 (0.01% - 100% motor speed)

Motor speed adjustment resolution

0.1% increments > 10% motor speed

0.01% increments > 1% motor speed and < 10%

0.001% increments < 1% motor speed

Maximum viscosity

12,000 Centipoise

Maximum suction lift:

30 ft. Water, 0 psig (9.14 m, 0 bar)

Display

3 color VGA backlit LCD, UV resistant.

Display resolution

0.0 > 10% motor speed

0.00 > 1% motor speed and < 10%

0.000 < 1% motor speed

Display languages

English, Spanish, French or German selectable.

Keypad

Eleven button positive action tactile switch keypad.

Security

Programmable 4-digit password.

Non-Wetted components:

Enclosure:

413 Aluminum (Polyester powder coated)

Pump Head:

Valox® (PBT) thermoplastic

Pump Head Cover:

Polycarbonate for added strength and chemical resistance.

Permanently lubricated sealed motor shaft support ball bearing.

Cover Screws:

Stainless Steel

Roller Assembly:

Rotor:Valox® (PBT)

Rollers:PVDF/Nylon

Roller Bearings:SS Ball Bearings

Roller Shaft:316 Stainless Steel

Motor Shaft:

Chrome plated steel

TFD System Sensor pins:

Hastelloy C-276

Power Cord:

3 conductor, SJTW-A Water-resistant

Tube Installation Tool:

Glass Filled Nylon

Mounting Brackets and Hardware:

316 Stainless Steel

1.4 Features

- Peristaltic pump design does not have valves that can clog requiring maintenance.
- Self priming - even against maximum line pressure. By-pass valves are not required. Cannot vapor lock or lose prime. Syphoning cannot occur.
- Output rates to: 158.5 GPH (600 LPH) and pressures to 125 PSI (8.6 Bar).
- 10,000:1 turndown ratio with high resolution motor speed adjustment.
- No maintenance brushless variable speed motor.
- Specially engineered tubing for long life at high pressures.
- Patented Tube Failure Detection (TFD) system. Senses tube failure by detecting chemical in the pump head. No false triggering from condensation or washdown.
- Control Inputs include: 4-20mA, 0-10Vdc, and Pulse inputs for remote external speed or batch control and 0-30 VDC / contact closure remote start/stop.
- Revolution count display with user programmable alarm set-point for tube maintenance.
- VGA Graphic multi-color backlit LCD displays remote/local control status, motor speed, output rate, input signal values, service and alarm status in three easy to see colors.
- Outputs include: Scalable 4-20mA or pulse, one 250V/6A relay and three 115V/1A contact closures assignable to monitor various pump functions including TFD, FVS, revolution counter, remote/local, forward/reverse, input signals, output signals, motor on, motor fault, operating mode setting, and others.
- Two precision molded squeeze rollers and alignment rollers provide factory calibrated optimum squeeze for unparalleled accuracy and extra long tube life.
- Heavy duty rotor - single piece plastic rotor means no flexing and increased accuracy with no metal springs or hinges to corrode.
- Inject at maximum pressure in either direction (clockwise or counter clockwise).
- Compatible with Blue-White's output Flow Verification Sensor (FVS) system.

Enclosure Rating:

NEMA 4X: Constructed for either indoor or outdoor use to provide a degree of protection to personnel against incidental contact with enclosed equipment; to provide a degree of protection against falling dirt, rain, sleet, snow, windblown dust, splashing water, and hose-directed water; and that will be undamaged by external formation of ice on enclosure.

IP66: No ingress of dust; complete protection against contact. Water projected in powerful jets against enclosure from any direction shall have no harmful effects.

1.5 Agency Listings



This pump is certified to NSF/ANSI Standard 61 - Drinking Water System Components - Health Effects





This pump is ETL listed to conforms to the following:
 UL Standard 778 as a motor operated water pump
 CSA Standard C22.2 as process control equipment



This pump complies to the Machinery Directive 98/37/EC, BS EN 60204-1, Low Voltage Directive 73/23/EC BS EN 61010-1, EMC Directive 89/336/EC, BS EN 50081-1/BS EN 50082-1.

Symbol	Explanation
	WARNING, risk of electric shock
	CAUTION, refer to users' guide
	GROUND, protective conductor terminal

2.0 Installation

CAUTION 	Risk of chemical overdose. Be certain pump does not overdose chemical during backwash and periods of no flow in circulation system.
CAUTION 	Always wear protective clothing, face shield, safety glasses and gloves when working on or near your metering pump. Additional precautions should be taken depending on solution being pumped. Refer to MSDS precautions from your solution supplier.
CAUTION 	All diagrams are strictly for guideline purposes only. Always consult an expert before installing metering pump on specialized systems. Metering pump should be serviced by qualified persons only.

2.1 Mounting Location

- ✓ Choose an area located near the chemical supply tank, chemical injection point, and electrical supply. Install the pump where it can be easily serviced.
- ✓ Mounting brackets are included. Mount the pump to a secure surface using the enclosed mounting hardware.
- ✓ Mount the pump close to the injection point. Keep the inlet (suction) and outlet (discharge) pipe or tubing as short as possible. Longer discharge tubing increases back pressure at pump head.
- ✓ Keep the suction lift height as low as possible. Increased suction lift heights can decrease the pump's efficiency.
- ✓ A back flow prevention check valve is recommended at the injection point to prevent system fluid from flowing back through the pump during tube replacement or if the tube should rupture. **The check valve internals must be kept clean.** Any build up in the valve will **increase the pressure at the pump reducing the life of the pump tube.** Back flow check valves are available from the factory.
- ✓ The Flex-Pro does not require back pressure. Pressure regulator valves should **NOT** be used as back-flow prevention valves unless adjusted to the minimum possible opening pressure. **Any additional pressure at the pump will reduce the life of the pump tube.**
- ✓ A pressure relief valve is recommended at the discharge of the pump to prevent excessive pressure resulting in premature wear and damage to the pump tube in the event the discharge line becomes blocked.
- ✓ An anti-syphon valve is not required. While the tube is pinched, syphoning cannot occur. A ball-type shut-off valve is recommended on the discharge side of the pump, prior to the injection point, to prevent syphoning during pump maintenance and tube replacement.

2.2 Mounting Dimensions

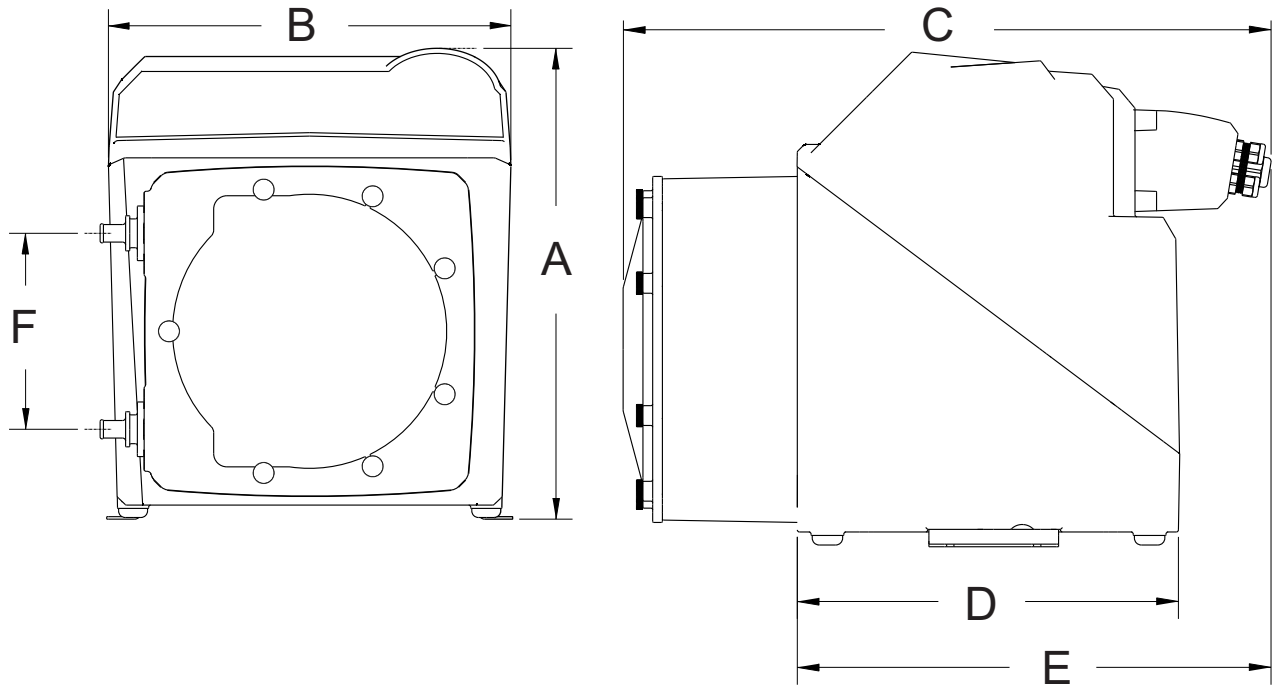

Dim	M-3 Series		M-4 Series	
	Inches	cm	Inches	cm
A	10-3/4"	27.3	14-1/4"	36.1
B	8-1/8"	20.6	12-1/8"	30.8
C	15-1/4"	38.9	18-5/8"	47.3
D	10"	25.4	11"	27.9
E	12-1/4"	31.0	13-5/8"	34.6
F	4-1/4"	10.7	6"	15.2

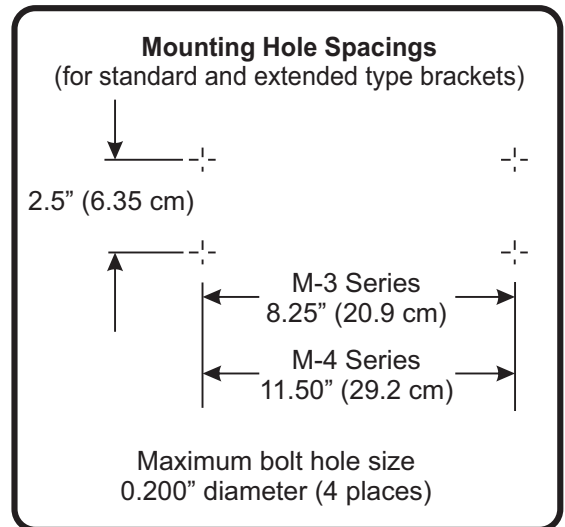

Extended Brackets

Stainless Steel extended brackets allow the pump to be securely mounted to most any surface; floor, shelf, or skid. Brackets lift the pump up 4-1/2 inches (11.43 cm), for easy pump access in hard to reach areas.

- Raise metering pump 4-1/2 inches (11.43 cm) off ground or a surface.
- Made out of tough Stainless Steel.
- Provides a stable mounting surface.



2.3 Input Power Connections

WARNING



Risk of electric shock – cord connected models are supplied with a grounding conductor and grounding-type attachment plug. To reduce risk of electric shock, be certain that it is connected only to a properly grounded, grounding-type receptacle.

WARNING



Electrical connections and grounding (earthing) must conform to local wiring codes. Be certain that a grounding conductor is connected to terminal T11-1 located in the wiring compartment.

WARNING



Risk of electric shock - Disconnect electricity before removing the wiring compartment cover.

- Be certain to connect pump to proper supply voltage. Using incorrect voltage will damage pump and may result in injury. Voltage requirement is printed on pump serial label.
- Input power range is 96VAC to 264VAC 50/60 Hz.
- Voltage Selection is automatically detected and adjusted by power supply. No mechanical switch necessary.
- Use voltage your power cord is rated for.
- Cord connected models are supplied with a ground wire conductor and a grounding type attachment plug (power cord). To reduce risk of electric shock, be certain that power cord is connected only to a properly grounded, grounding type receptacle.
- Permanently connected models must be properly grounded. Be certain that a grounding conductor is connected to terminal T11-1 located in the wiring compartment.
- Wiring compartment access requires removing 4 screws. A 5/32" (.156") allen wrench is required (included).
- Be sure all wiring compartment cable glands and hole plugs are properly installed and sealed.
- Never strap control (input / output) cables and power cables together.
- **Power Interruption:** This pump has a user programmable auto-restart feature which will can either restore the pump to the operating state it was in when power was lost or require a user action to restart.

Note: When in doubt regarding your electrical installation, contact a licensed electrician.

WIRING COMPARTMENT COVER

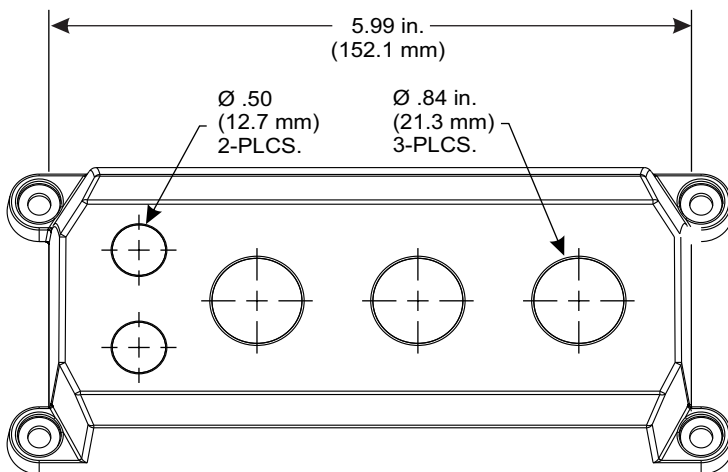

Cable and conduit connectors included

QTY. DESCRIPTION

- | | |
|---|---|
| 2 | .50 INCH (12.7 mm) LIQ-TIGHT HOLE PLUGS (MAT'L = NEOPRENE), PRE-INSTALLED |
| 3 | .875 INCH (22.2 mm) LIQ-TIGHT HOLE PLUGS (MAT'L = NEOPRENE), 2 PRE-INSTALLED |
| 2 | .50 INCH (12.7 mm) LIQ-TIGHT CONNECTORS FOR PASS THRU CORDS (MAT'L = NYLON) ACCEPTABLE CABLE DIAMETER .118 TO .255 INCH (3.0 TO 6.5 MM), NOT INSTALLED |
| 3 | .875 INCH (22.2 mm) METALLIC LIQ-TIGHT CONNECTORS FOR PASS THRU CORDS (MAT'L = NYLON) ACCEPTABLE CABLE DIAMETER .200 TO .395 INCH (5.1 TO =10.0 MM), 1 PRE-INSTALLED WITH POWER CORD MODELS |
| 2 | METALLIC LIQ-TIGHT CONNECTORS FOR .50 INCH FLEXIBLE CONDUIT (MAT'L = DIE CAST ZINC), NOT INSTALLED |

POWER CORD OPTIONS

Three power cord plug types available.
Power cord length is 6 feet (3.83 meters)



115V 60Hz
NEMA 5/15 (USA)
max: 125V AC

230V 60Hz
NEMA 6/15 (USA)
max: 250V AC

240V 50Hz
CEE 7/VII (EU)
max: 250V AC

2.4 Wiring Terminals and I/O Schematics

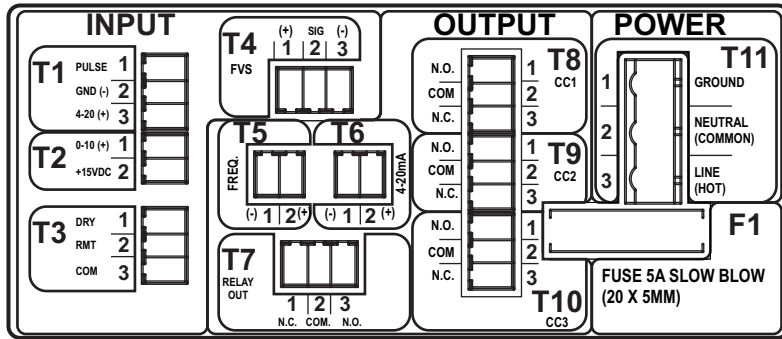

WARNING
Risk of electric shock - All wiring must be insulated and rated 300V minimum.

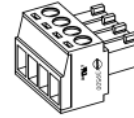

Terminals T1 thru T10
Plug type
16 - 24 AWG

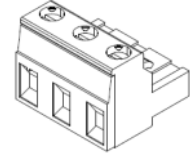

Power Input Terminal T11
Plug type
14 - 30 AWG

Shielded cables should be used on all input signal wires.

FUNCTION	TERMINAL	PIN #	RATING	ELECTRICAL SP.	BLOCK DIAGRAM
INPUT: 4-20 mA	T1	3	(+) POSITIVE	120 OHM IMPEDANCE, NON POWERED LOOP	<p>(-) ACTIVE 4-20mA TRANSMITTER (+) SOURCE</p>
	T1	2	(-) NEGATIVE		
INPUT: FREQUENCY, AC SINE WAVE, TTL, CMOS	T1	1	(+) POSITIVE	0-1000 HZ MAX.	<p>(+) FREQUENCY TRANSMITTER (-) SOURCE</p>
	T1	2	(-) NEGATIVE		
INPUT: 0-10V DC	T2	1	(+) POSITIVE		<p>(-) 0-10V DC TRANSMITTER (+) SOURCE</p>
	T1	2	(-) NEGATIVE		
INPUT: FVS SYSTEM (FLOW VERIFICATION SENSOR) FV SENSOR ONLY	T4	1	(+) POSITIVE		<p>BLACK (-) BARE RED (+)</p>
	T4	2	SIGNAL		
	T4	3	(-) NEGATIVE		
INPUT: FVS SYSTEM (FLOW VERIFICATION SENSOR) FS or FP MICRO-FLO FLOWMETER ONLY	T4	1	(+) POSITIVE		<p>NEGATIVE (-) SIGNAL</p>
	T4	2	SIGNAL		
	T4	3	(-) NEGATIVE		
INPUT: REMOTE START / STOP (DRY CONTACT C.)	T3	1	(-) NEGATIVE	NO VOLTAGE	<p>(-) OPEN CIRCUIT IMPEDANCE MUST BE GREATER THAN 50K OHM</p>
	T3	2	(+) POSITIVE		
INPUT: REMOTE START / STOP (WET CONTACT C.)	T3	2	(+) POSITIVE	3 TO 30 VOLT DC 1 AMP MAX.	<p>(+) EXTERNAL DEVICE 3 TO 30V DC</p>
	T3	3	(-) NEGATIVE		
OUTPUT: 4-20 mA	T6	2	(+) POSITIVE	120 OHM RESISTANCE ACTIVE LOOP	<p>(-) 4-20mA RECEIVER (+) 600 OHM LOAD MAX.</p>
	T6	1	(-) NEGATIVE		
OUTPUT: FREQUENCY - OPEN COLLECTOR	T5	2	(+) POSITIVE	OPEN COLLECTOR 0-1000 HZ 50% DUTY CYCLE	<p>(-) DIGITAL PULSE RECEIVER CIRCUIT (+) EXTERNAL SOURCE 1.5K OHM 6-30V DC</p>
	T5	1	(-) NEGATIVE		
OUTPUT: RELAY, 6 AMP	T7	1	NORM. CLOSED	Form C 6 AMP MAX AT 250 VAC, 5 AMP MAX AT 30 VOLT DC	<p>NC C NO</p>
	T7	2	COMMON		
	T7	3	NORM. OPEN		
OUTPUT: CONTACT CLOSURE 1	T8	1	NORM. OPEN	Form C 1 AMP MAX AT 125 VOLT AC, 0.8 AMP MAX AT 30 VOLT DC	<p>NO C NC</p>
	T8	2	COMMON		
	T8	3	NORM. CLOSED		
OUTPUT: CONTACT CLOSURE 2	T9	1	NORM. OPEN	Form C 1 AMP MAX AT 125 VOLT AC, 0.8 AMP MAX AT 30 VOLT DC	<p>NO C NC</p>
	T9	2	COMMON		
	T9	3	NORM. CLOSED		
OUTPUT: CONTACT CLOSURE 3	T10	1	NORM. OPEN	Form C 1 AMP MAX AT 125 VOLT AC, 0.8 AMP MAX AT 30 VOLT DC	<p>NO C NC</p>
	T10	2	COMMON		
	T10	3	NORM. CLOSED		
INPUT: POWER	T11	1	GROUND	96 TO 264 VOLT AC, 50 / 60 HZ A3 = 220W A4 = 350W	<p>GROUND 1 NEUTRAL (COMMON) 2 LINE (HOT) 3</p>
	T11	2	NEUTRAL		
	T11	3	LINE (HOT)		
FUSE	F1	NA	5 AMP	5A SLOW BLOW (20 X 5MM)	

NOTE: USE ONLY DRY CONTACT FOR REMOTE S/S WHEN USING 4-20mA INPUT OR 0-10V DC

3.0 How To Operate Flex-Pro

Flex-Pro M Series, Control Panel - Button Operation

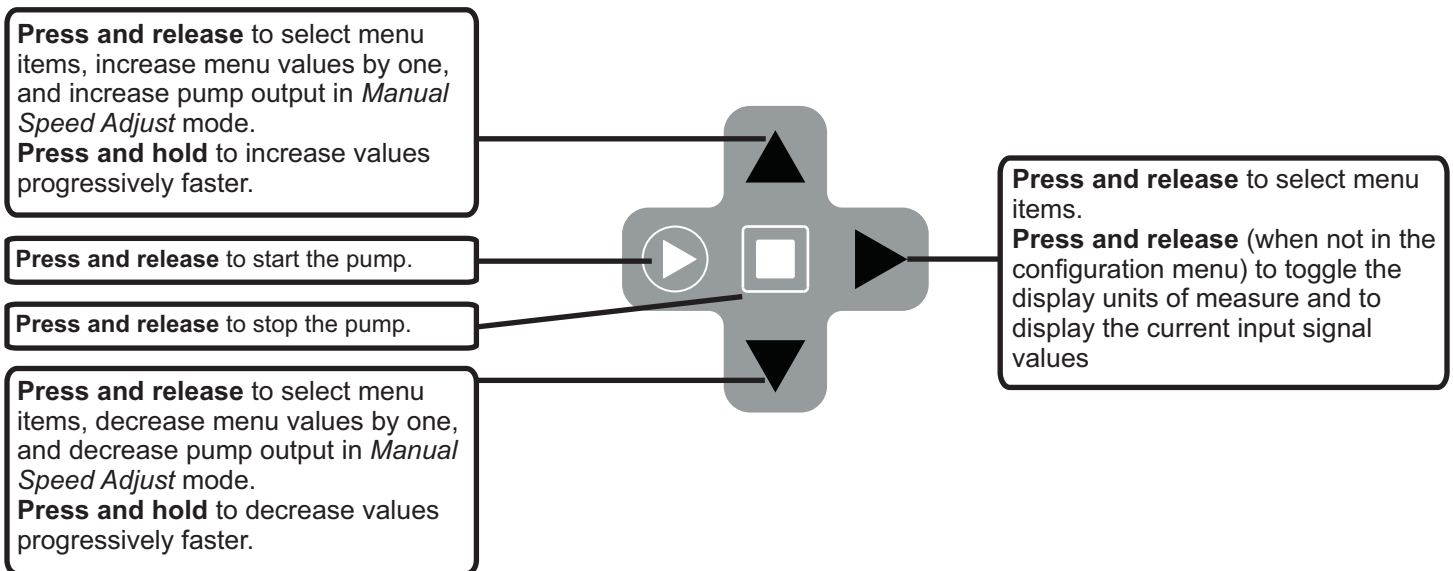
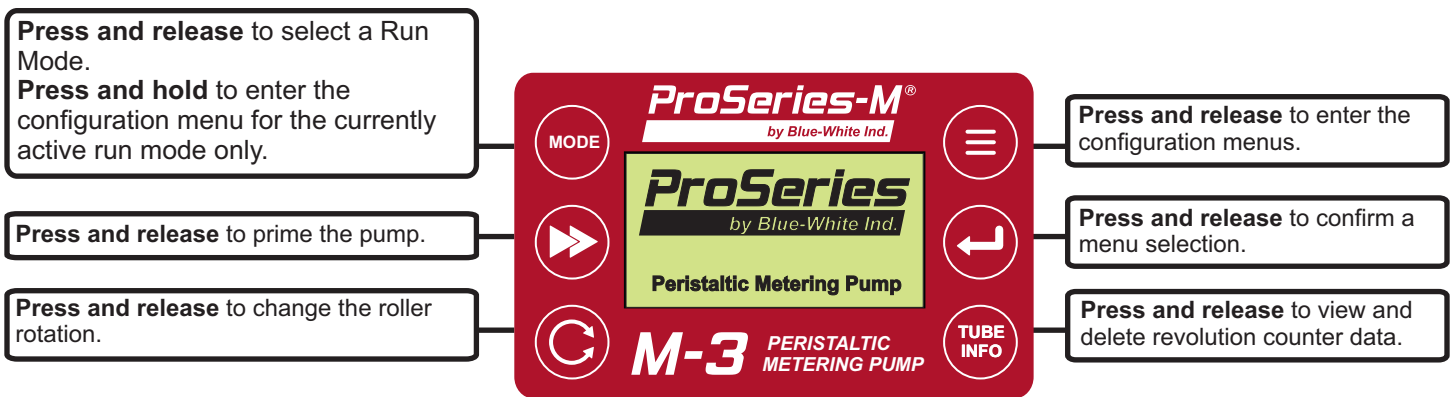

3.1 Menu Navigation

Use MENU button to enter menu for setting up pump.

Use UP or DOWN arrows to navigate through menu.

Active option appears on pump display in **inverse** text.

Plus symbol **+** signifies top of a menu tree. This means you can go further within the menu.

Within the Menu of the pump, each screen you enter will have a title located along the top. This will display the menu that is currently active, or this will be the setting you are configuring.

To back out of menu, select **<- Esc** line located at end of the list. Then press ENTER button. This will take you back one level.

When the menu list extends above or below height of display, a scroll bar will appear on left side. Press DOWN arrow to scroll down to the end of the list to see a list of all the available options.

Scroll bar example:



While making a selection where only one choice is allowed, you will see a radio button.

Radio button example: Solid black means item is selected
 Outline with no fill means item is not selected

In a screen where you are making changes, you will see the word **Done** located at the bottom of the list. You must select **Done** in order to leave the screen (whether you made a change or not). Selecting **Done** will take you back to the parent level.

When inputting a numerical value, use UP or DOWN arrow to scroll through 0 - 9. To move over to the next digit use RIGHT arrow. If you pass your desired digit, you can continuously press RIGHT arrow until you reach your desired digit.

Numeric value example:

- Sample screen shots -

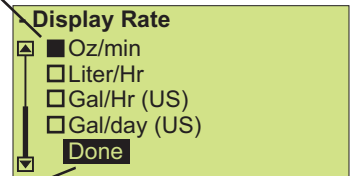
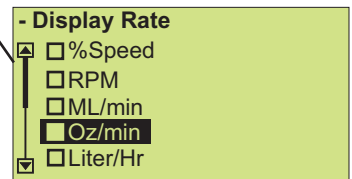
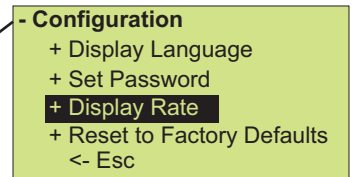
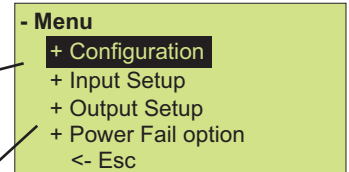

3.2 Configuration Menu

Below is the menu structure for the Configuration screens.

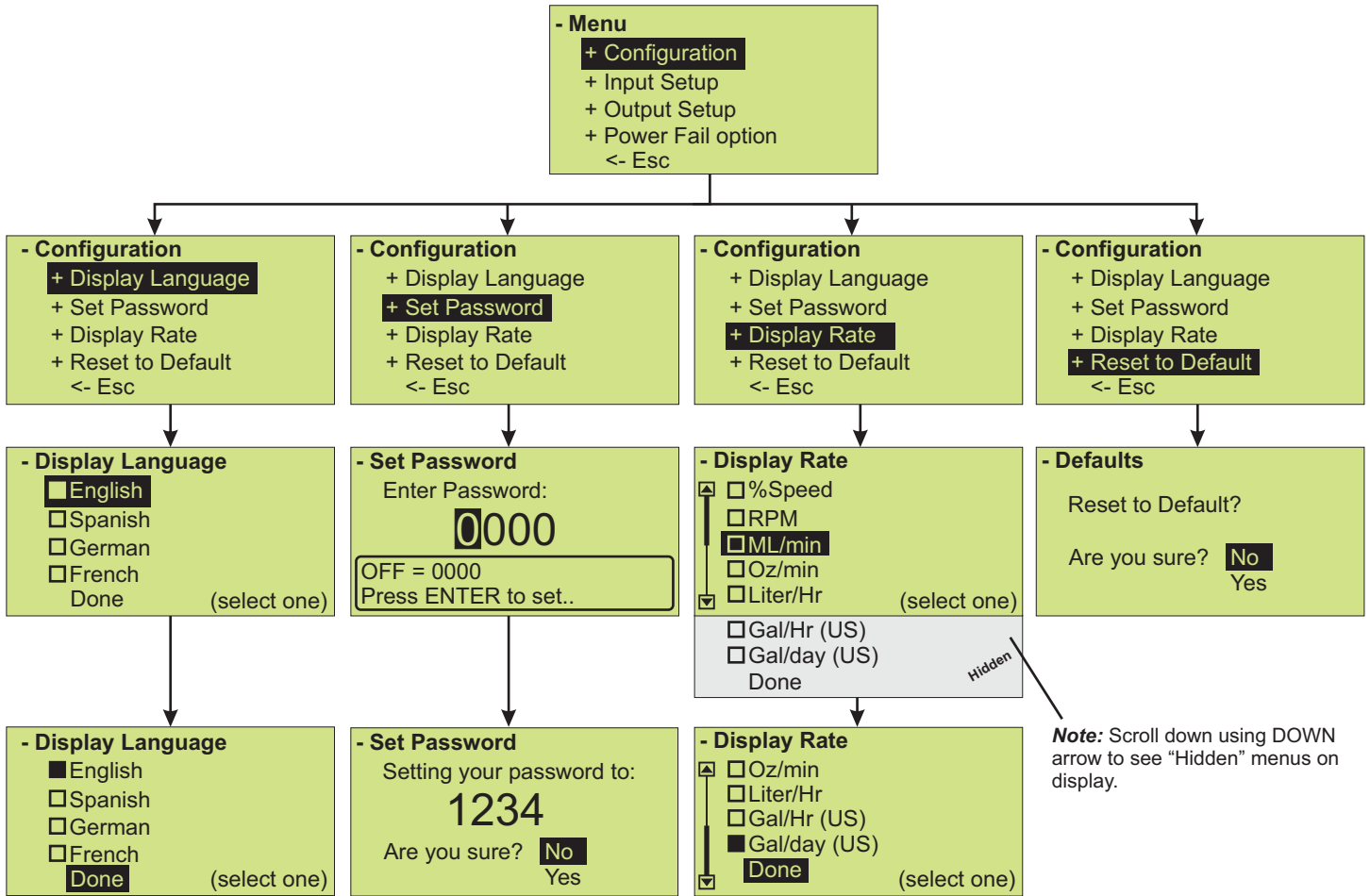

3.2.1 Language Selection

Press MENU button to enter the menu structure.

Select **Configuration** and Press ENTER button.

Select **Display Language** and Press ENTER button.

Select your desired language, then Press ENTER.

Note: English is the default language.

Select **Done** at bottom of list to confirm your selection. Press ENTER button.

Select **<-Esc** on the main menu screen to exit the menu structure and enter the run mode.

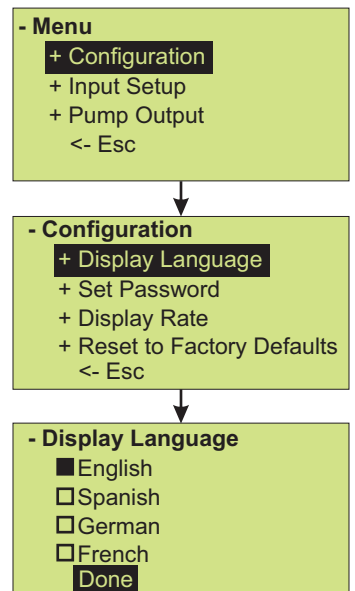

3.2.2 Display Rate (Units of Measure)

By default, the pump will display %Speed (motor speed) and RPM. It is recommended you select an additional **Display Rate**. After selecting another **Display Rate** (such as ML/Min), the pump display may be toggled through %Speed, RPM and your selected Display Rate by pressing the right arrow button.

Press MENU button to enter the menu structure.

Select **Configuration** and Press ENTER button.

Select **Display Rate** and Press ENTER button.

Select your desired Display Rate (unit of measure). Note: %Speed and RPM will always be active and available to view while pump is in operation.

Select **Done** at the bottom of the list to confirm your selection and to return back to the previous screen. Press ENTER button.

Select **<-Esc** on the main menu screen to exit the menu structure and enter the run mode.

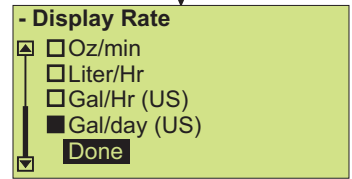
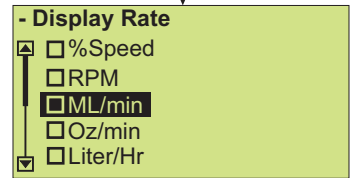
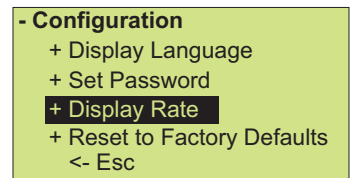

Tip! While pump is operating in any Run Mode, press RIGHT arrow to scroll through multiple read-only screens including output rate and input signal values.

Note: This is a read-only feature, no changes can be made while in Run Mode.



3.2.3 Reset Factory Defaults

This will reset pump to the factory defaults. This will restore the pump to the original configuration when it left the factory.

Press MENU button to enter menu structure.

Select **Configuration** and Press ENTER button.

Select **Reset to Factory Defaults** and Press ENTER button.

Select **No** or **Yes**, then ENTER button.

Select **<-Esc** on the main menu screen to exit the menu structure and enter the run mode.

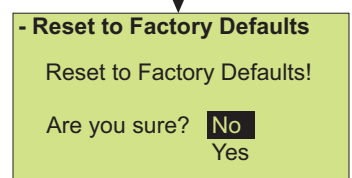
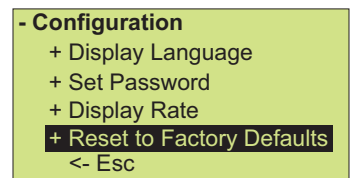

4.0 Input Setup

Below is the menu structure for the INPUT SETUP selection.

Max RPM cut-off - 4.1

To Select a maximum motor RPM. Input the maximum RPM value.

Max Flowrate - 4.2

To calibrate your pump. This setting is pre-configured at the factory based on the tube size supplied when ordered. Pump has been calibrated with water. You can re-calibrate pump. Input the calibrated ml/min at 100% motor speed.

Input Modes - 4.3

To configure your pump's Run Modes. Use this menu to setup your desired operating mode. This manual will cover each step in detail later.

Contact Input - 4.4

(remote start/stop)
Contact Closure Input feature is used to Start and Stop pump remotely. Default setting is DISABLE.

Set FVS - 4.5

(Flow Verification System)
Set Flow Verification time delay. Use this feature if you are using a Blue-White flow verification sensor to monitor flow output. Default setting is OFF.

Set TFD - 4.6

(Tube Failure Detection)
Set Tube Failure Detection sensitivity. Use this feature to increase the sensitivity to your chemical. Default setting is 75%.

Set Remote/Local control - 4.7

(Control panel touch pad lockout)
Select remote to disable the touch pad buttons enabling input signal control only. When remote is selected, the user must select an input operating mode. Select Local to disable all input signals and allow local touch pad control only.

Set Revolution Alarm - 4.8

(number of roller revolutions)
Set the number of revolutions required to trigger the display alarm (display turns red) and to trigger the output contact closure.

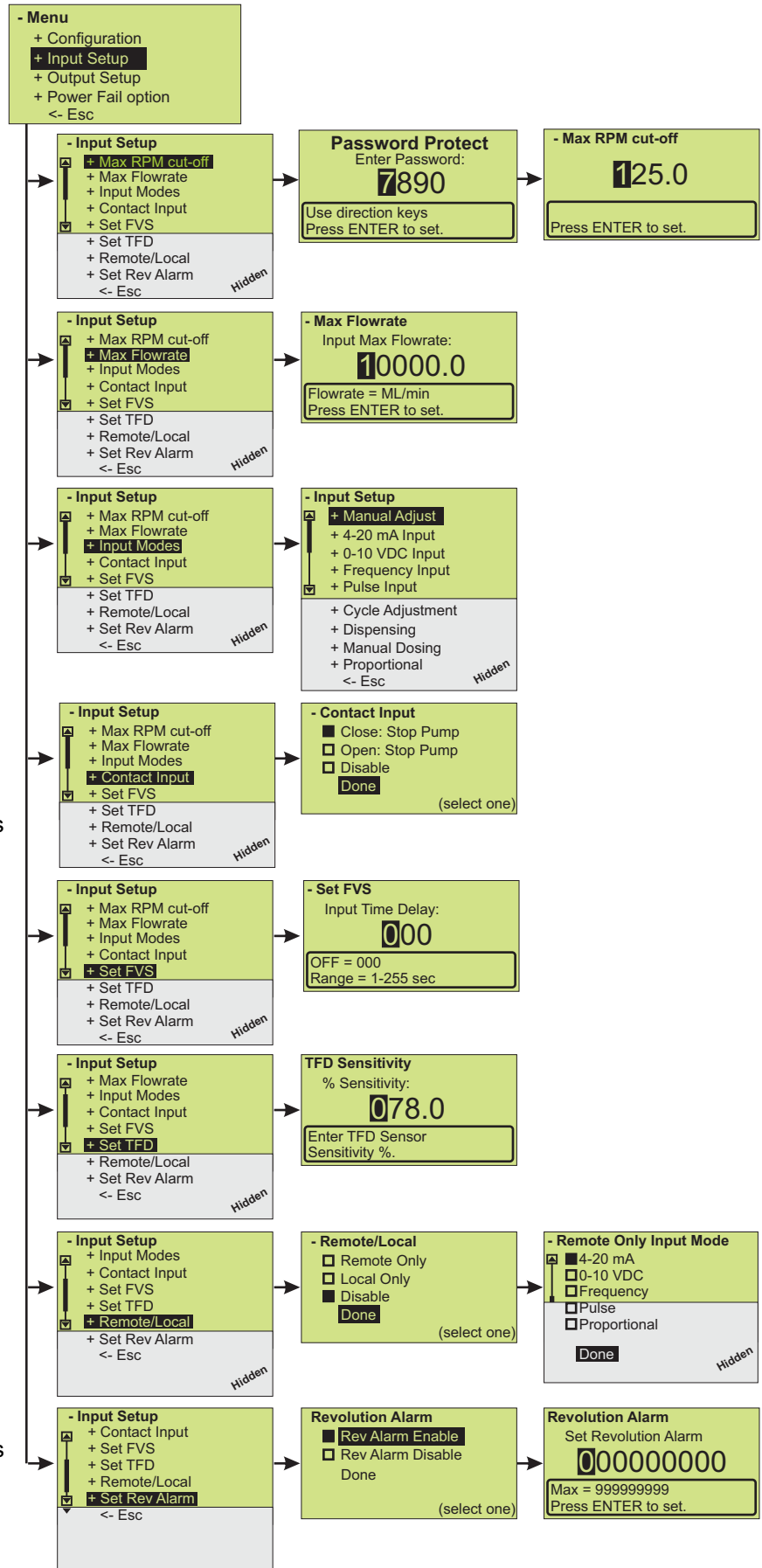

4.1 Max RPM cut-off

The maximum motor RPM can be limited to reduce the possibility of overfeeding chemical into the system. Note that the pump's display will still reference values calculated from the 100% motor speed MAX Flowrate value (see section 4.2). Also, the pump % motor speed will still be referenced from 125 RPM, the maximum possible motor RPM. For example, if the pump speed is set for 25%, the display will indicate 32.3 RPM. The prime mode RPM is limited to the Max RPM value.

Select **Max RPM cut-off** and Press ENTER button. Use the direction arrows to enter the password 7890.

Press UP or DOWN arrow to scroll through 0 - 9 on selected digit.

Press RIGHT arrow to scroll over to next digit to right. If you pass your desired digit, you can easily scroll back by continuously pressing RIGHT button.

Press ENTER to save changes.

Select **<-Esc** on the main menu screen to exit the menu and enter the run mode.

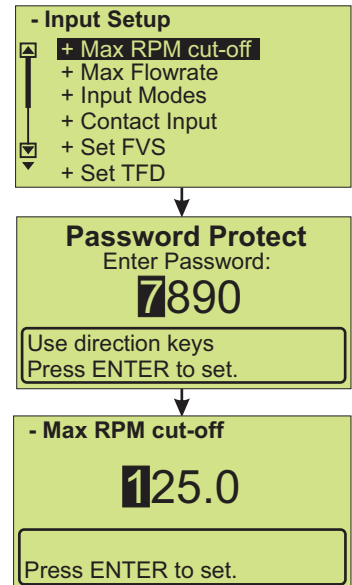

4.2 MAX Flowrate (output calibration)

The MAX Flowrate value is equal to the pump's measured fluid output in milliliters per minute, at the 100% motor speed adjustment setting. The pump uses the MAX flow rate value to calculate motor speed for various operating functions and to display output values.

Each Flex-Pro pump is calibrated at the factory and shipped with a calibrated pump tube assembly installed. The MAX flow rate value can be adjusted at any time. To achieve high accuracy, a field calibration under the actual operating conditions should be performed and the Max Flowrate value changed to reflect the calibrated amount. Multiply the **Max Flowrate** value by the percentage of error at your calibrated flow rate to obtain the new **Max Flowrate** value.

Select **Max Flowrate** and Press ENTER button.

Press UP or DOWN arrow to scroll through 0 - 9 on selected digit.

Press RIGHT arrow to scroll over to next digit to right. If you pass your desired digit, you can easily scroll back by continuously pressing RIGHT button.

Press ENTER to save changes.

Select **<-Esc** on the main menu screen to exit the menu structure and enter the run mode.

Every pump tube assembly model number has a published maximum flow rate value which is based on laboratory tests pumping water at room temperature at 36" suction lift against 0 psi back pressure. Your actual output may vary due to fluid viscosity, fluid temperature, suction lift height, piping system layout, manufacturing tolerances and to a lesser degree, variations in system pressure and tubing wear.

To achieve high accuracy, the pump's output should be measured (calibrated), and the MAX Flowrate value (in milliliters per minute) updated, whenever any of the following conditions exist:

- At the initial pump start up.
- When a new tube assembly is installed. *Run the pump with or without fluid for approximately 30 minutes prior to calibration.*
- When the piping system configuration is changed.
- When the suction lift height is changed.
- Periodically during the life of the tube. *Output variances are most noticeable prior to tube failure.*

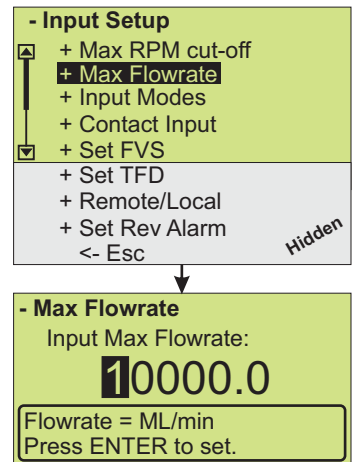

To calculate the Max Flowrate:

To determine the amount of error at your output setting, divide the actual output amount by the indicated output. Then multiply the resulting percentage of error by the **Max Flowrate** value currently showing in the pump.

Example: If the pump display indicates the output is 170 ml/min but the actual measured output is 160 ml/min, calculate the percentage of error by: $160/170 = 0.941$. Multiply the **Max Flowrate** value by 0.941 and enter this new value.

4.3 Input Setup (operating mode configuration)

Tip! MODE button also serves as a shortcut button.
Press and Hold MODE button to enter the programming menu for the current Run Mode. After programming the Run Mode, press ENTER to save changes. **Press and Hold** MODE button to exit the program menu back to the current Run Mode of the pump.
Press START button to start the pump with the new settings applied.

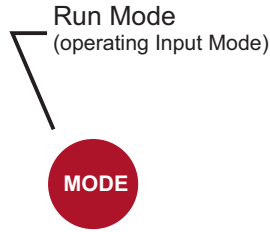

4.3.1 Manual Adjust (manual speed adjust)

Used to manually control the speed of pump. Set % (percent) Motor Speed in this menu.

Press SELECT RUN MODE button until **Manual Speed Adjust** is displayed in the top line of the display.

To configure the pump output speed, navigate to **Manual Speed Adjust** menu by using the short-cut method described above, or by pressing MENU button, then selecting Input Setup, Input Modes, and then **Manual Adjust**.

Press UP or DOWN arrow to scroll through 0 - 9 on selected digit.

Press RIGHT arrow to scroll over to next digit to right. If you pass your desired digit, you can easily scroll back by continuously pressing RIGHT button.

Press ENTER to save changes.

If you used the short-cut to enter Manual Speed Adjust setup, press and hold the Select Run Mode button until the Run Mode screen is displayed.

If you used the Menu button to navigate to the Manual Speed Adjust setup, you must navigate back out of the menu structure. To do this you must select <-Esc at the bottom of every screen menu until you see the Run Mode screen displayed.

Tip! The **Manual Speed Adjust** mode can be combined with **Contact Input** feature to allow for remote Start and Stop of pump. Can be used with PLC, foot pedal, push button, or other external controls.

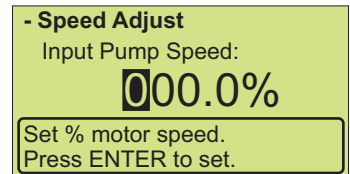

Tip! In Manual Speed Adjust mode, you can view the pump output by pressing RIGHT arrow. RIGHT arrow is a convenient way to scroll through multiple read-only screens during normal pump operation.

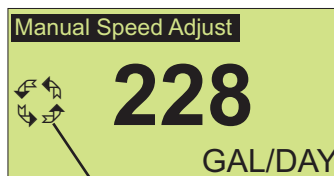

Displays current rotor direction

4.3.2 4 - 20 mA Input

Used to remotely control the pump with an incoming 4-20 mA signal.

Default settings: 4 mA = 0% motor speed
20 mA = 100% motor speed

Press MODE button until **4 - 20 mA Input** is displayed in the top line of the display.

To configure the pump, navigate to **4 - 20 mA Input** menu by using the short-cut method described at the beginning of section, or by pressing MENU button, then selecting Input Setup, Input Modes, and then **4 - 20 mA Input**

Four points on the slope must be defined; 1) a low mA value, 2) an output rate at the low mA value, 3) a high mA value, and 4) an output rate at the high mA value.

To input mA values, press the RIGHT ARROW to select the digit to change, press UP or DOWN arrow to scroll through 0 - 9 on selected digit. Press enter to save changes and move to the next input screen.

To input flow rate values, press the RIGHT ARROW to select the user defined flow rate unit of measure, motor RPM, or %Speed values. Press UP or DOWN arrow to increase or decrease the value. Press and hold the arrow to increase or decrease progressively faster. Press enter to save changes and move to the next input screen.

Continue this process until all four screens have been configured.

If you used short-cut to enter 4-20 mA input setup, press and hold the Mode button until the Run Mode screen is displayed.

If you used Menu button to navigate to 4-20 mA input setup, you must navigate back out of menu structure. To do this you must select <-Esc at bottom of every screen menu until you see Run Mode screen displayed.

Note: The pump is designed to fail safe. If the input signal drops below 3.0 mA, the pump assumes a lost signal and the motor speed is set to 0 RPM.

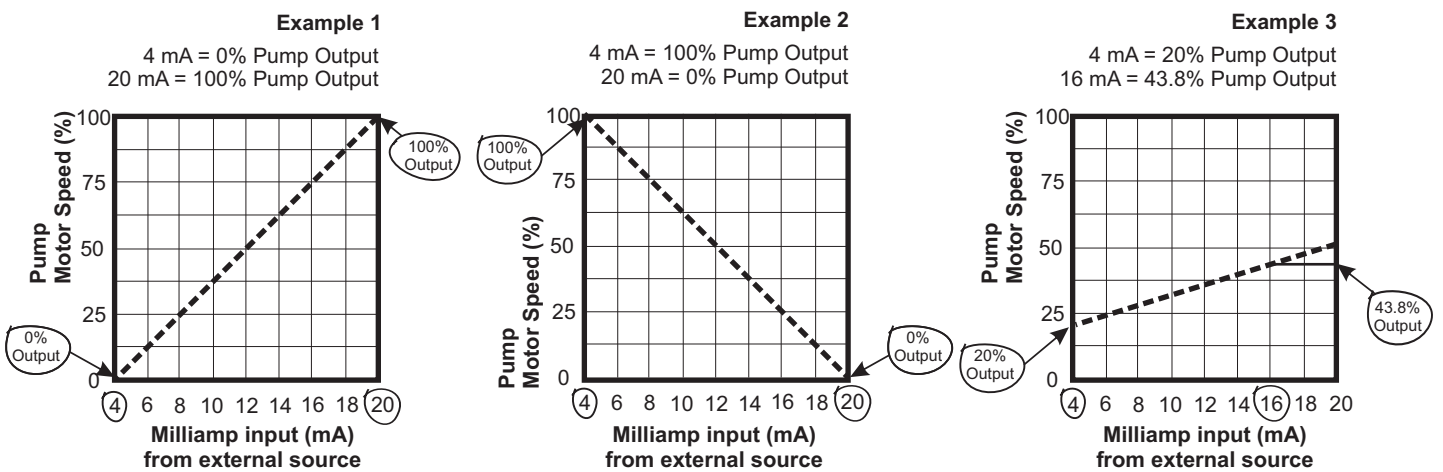
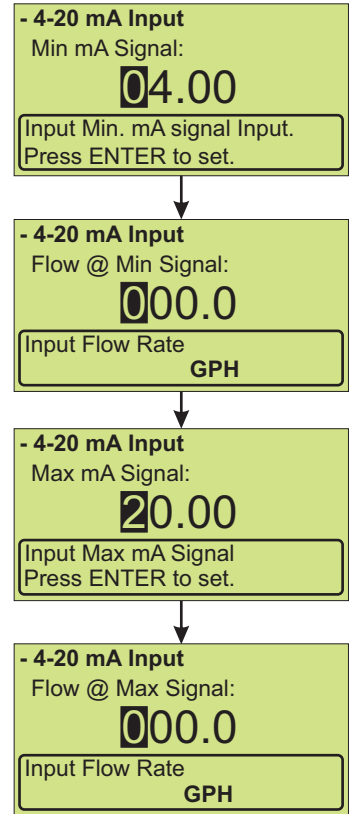

4.3.3 0 - 10 VDC Input (Volt DC)

Used to remotely control the pump with an incoming 0-10 VDC signal.

Default settings: 0 VDC = 0% motor speed
10 VDC = 100% motor speed

Press MODE button until **0 - 10 VDC Input** is displayed in the top line of the display.

To configure the pump, navigate to **0 - 10 VDC Input** menu by using the short-cut method described at the beginning of the section, or by pressing MENU button, then selecting Input Setup, Input Modes, and then **0 - 10 VDC Input**.

Four points on the slope must be defined; 1) a low VDC value, 2) an output rate at the low VDC value, 3) a high VDC value, and 4) an output rate at the high VDC value.

To input VDC values, press the RIGHT ARROW to select the digit to change, press UP or DOWN arrow to scroll through 0 - 9 on selected digit. Press enter to save changes and move to the next input screen.

To input flow rate values, press the RIGHT ARROW to select the user defined flow rate unit of measure, motor RPM, or %Speed values. Press UP or DOWN arrow to increase or decrease the value. Press and hold the arrow to increase or decrease progressively faster. Press enter to save changes and move to the next input screen.

Continue this process until all four screens have been configured.

If you used the short-cut to enter 0 - 10 VDC Input setup, press and hold Mode button until Run Mode screen is displayed.

If you used the Menu button to navigate to 0 - 10 VDC Input setup, you must navigate back out of menu structure. To do this you must select <-Esc at bottom of every screen menu until you see Run Mode screen displayed.

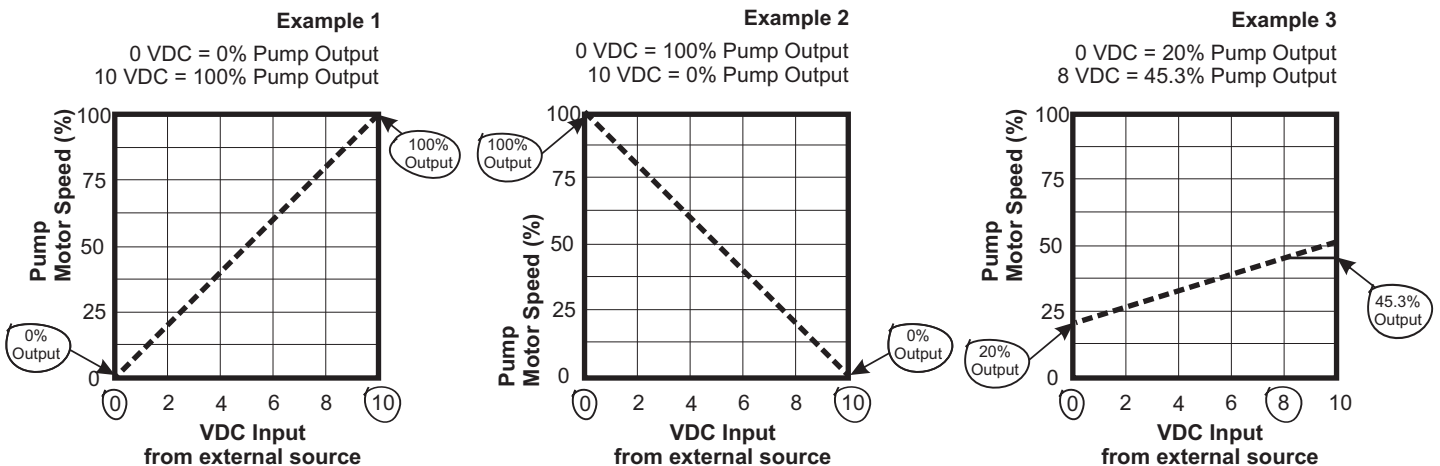
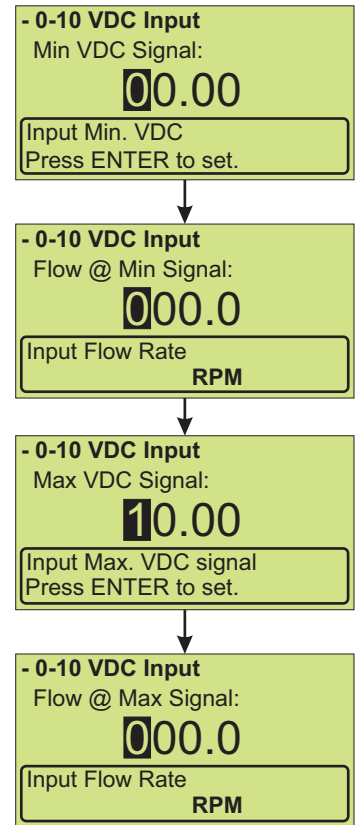

Tip! When in the run mode, you can view the current pump output speed and input signal values by pressing the RIGHT arrow.

4.3.4 Frequency Input (Hz)

Used to remotely control the pump with an incoming high speed frequency signal. Typically used with flow meters or other external devices.

Default settings: 0 Frequency (Hz) = 0% motor speed
1000 Frequency (Hz) = 100% motor speed

Press MODE button until **Frequency Input** is displayed in the top line of the display.

To configure the pump, navigate to **Frequency Input** menu by using the short-cut method described at the beginning of section, or by pressing MENU button, then selecting Input Setup, Input Modes, and then **Frequency Input**.

Four points on the slope must be defined; 1) a low Hz value, 2) an output rate at the low Hz value, 3) a high Hz value, and 4) an output rate at the high Hz value.

To input Hz values, press the RIGHT ARROW to select the digit to change, press UP or DOWN arrow to scroll through 0 - 9 on selected digit. Press enter to save changes and move to the next input screen.

To input flow rate values, press the RIGHT ARROW to select the user defined flow rate unit of measure, motor RPM, or %Speed values. Press UP or DOWN arrow to increase or decrease the value. Press and hold the arrow to increase or decrease progressively faster. Press enter to save changes and move to the next input screen.

Continue this process until all four screens have been configured.

If you used the short-cut to enter Frequency Input setup, press and hold Mode button until Run Mode screen is displayed.

If you used the Menu button to navigate to Frequency Input setup, you must navigate back out of menu structure. To do this you must select <-Esc at bottom of every screen menu until you see Run Mode screen displayed.

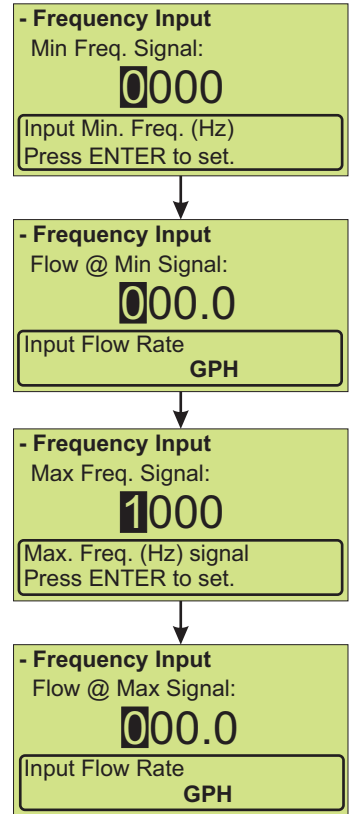

Examples:

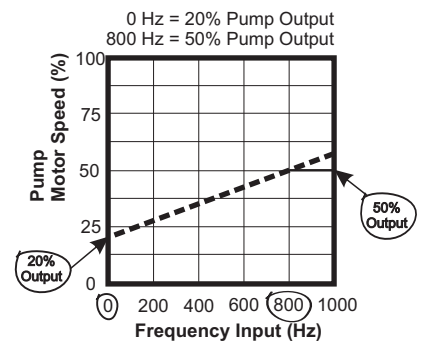
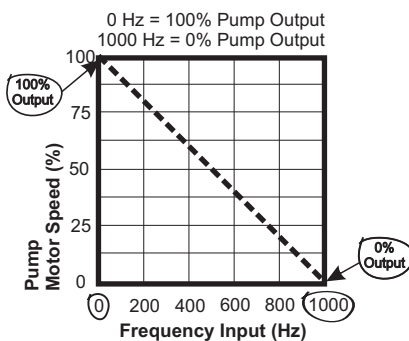
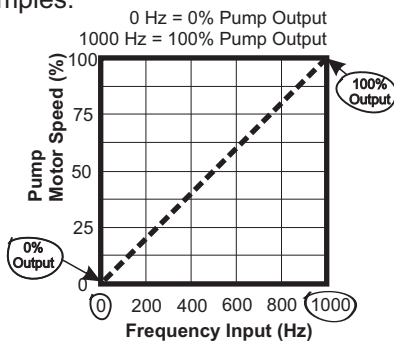

Tip!

When in the run mode, you can view the current pump output speed and input signal values by pressing the RIGHT arrow.

4.3.5 Pulse Batch (low speed pulse)

Used to remotely control the pump with an incoming pulse signal. Can be used with an external foot pedal, a water meter, a PLC, contact closure, or other low speed pulse devices.

Default settings: 1 Pulse = 100% motor speed for 2.5 seconds

Press MODE button until **Pulse Batch** is displayed in the top line of the display.

To configure the pump, navigate to **Pulse Batch** menu by using the short-cut method described at beginning of section, or by pressing MENU button, then selecting Input Setup, Input Modes, and then **Pulse Batch**.

Press UP or DOWN arrow to scroll through 0 - 9 on selected digit.

Press RIGHT arrow to scroll over to the next digit to the right. If you pass your desired digit, you can easily scroll back by continuously pressing the RIGHT button.

Press ENTER to save the changes.

Continue this process until all three screens have been configured.

If you used the short-cut to enter Pulse Batch setup, then just press and hold Mode button until the Run Mode screen is displayed.

If you used the Menu button to navigate to Pulse Batch setup, you must navigate back out of menu structure. To do this you must select <-Esc at bottom of every screen menu until you see Run Mode screen displayed.

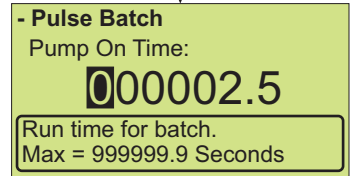
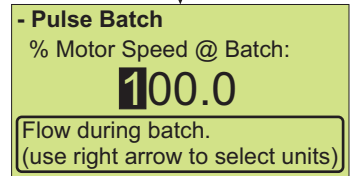
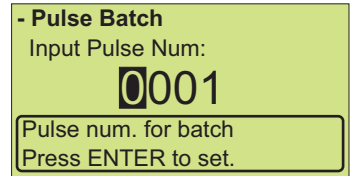

Tip!



While operating in Pulse Batch mode, you can view the current incoming signal count by pressing the RIGHT arrow.

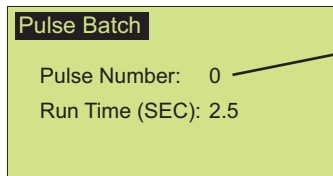

Displays current incoming signal

4.3.6 Manual Cycle Adjust (repeating cycle timer)

Used to operate the pump at a pre-selected motor speed for a specified run time. This cycle will repeat itself using a repeating cycle timer.

Default settings: 100% motor speed for 1.5 seconds
Repeating cycle timer = 4 seconds

Press MODE button until **Manual Cycle Adjust** is displayed in the top line of the display.

To configure the pump, navigate to **Manual Cycle Adjustment** menu by using the short-cut method described at the beginning of the section, or by pressing MENU button, then selecting Input Setup, Input Modes, and then **Cycle Adjustment**.

Press UP or DOWN arrow to scroll through 0 - 9 on selected digit.

Press RIGHT arrow to scroll over to next digit to the right. If you pass your desired digit, you can easily scroll back by continuously pressing RIGHT button.

Press ENTER to save the changes.

Continue this process until all three screens have been configured.

If you used the short-cut to enter Manual Cycle Adjustment setup, press and hold Mode button until Run Mode screen is displayed.

If you used the Menu button to navigate to Cycle Adjustment setup, you must navigate back out of menu structure. To do this you must select <-Esc at bottom of every screen menu until you see Run Mode screen displayed.

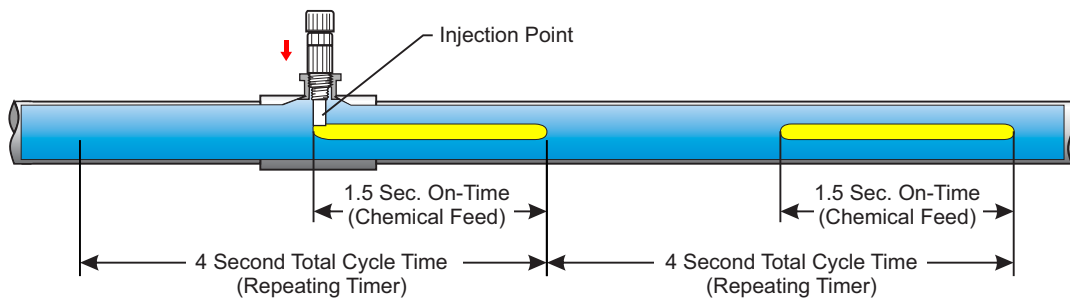
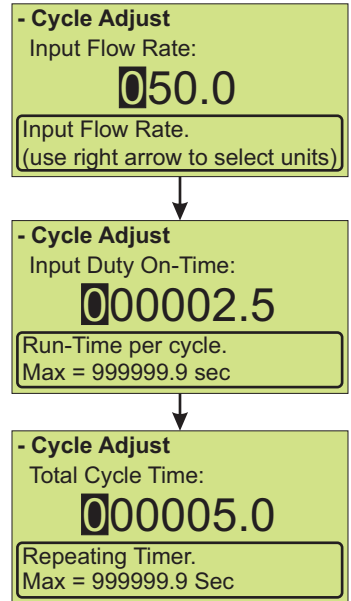

Graphical representation of Manual Cycle Adjust injection characteristics.

Note: Your chemical or solution is mixed in fluid. This image is only illustrating feed characteristics.

Tip!

While in Manual Cycle Adjust mode, you can view current settings by pressing the RIGHT arrow.

Manual Cycle Adjust

Cycle (SEC.): 4.0
On Time (SEC.) 1.5

4.3.7 Dispensing

Configure any dispensing amount or sample size and the pump will repeat it on command by pressing the START button. Great for accurate single shot dispensing of a pre-configured volume.

Default settings: 1000 milliliters
 50% pump speed

Press MODE button until **Dispensing** is displayed in the top line of the display.

To configure the pump, navigate to **Dispensing** menu by using the short-cut method described at beginning of the section, or by pressing MENU button, then selecting Input Setup, Input Modes, and then **Dispensing**.

Press UP or DOWN arrow to scroll through 0 - 9 on selected digit.

Press RIGHT arrow to scroll over to next digit to the right. If you pass your desired digit, you can easily scroll back by continuously pressing RIGHT button.

Press ENTER to save the changes.

Continue this process until two screens have been configured.

If you used the short-cut to enter Dispensing setup, press and hold Mode button until Run Mode screen is displayed.

If you used the Menu button to navigate to Dispensing setup, you must navigate back out of menu structure. To do this you must select <-Esc at bottom of every screen menu until you see Run Mode screen displayed.

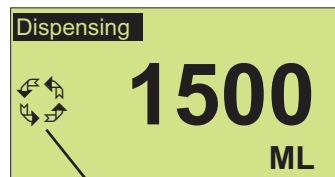
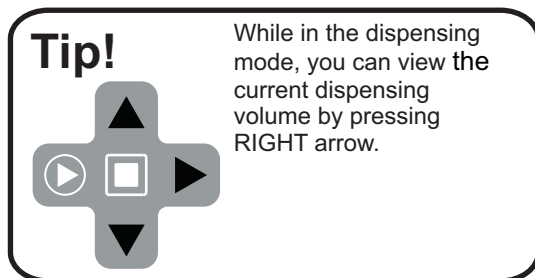
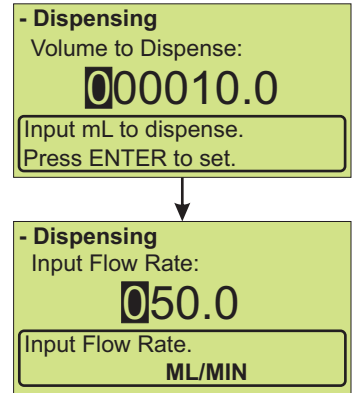

Displays current rotor direction

4.3.8 Manual Dosing

Used to configure Parts Per Million dosing to a system. This method can be used if treated fluid volume is a fixed amount (in Liters Per Minute). If treated fluid volume is variable (continuous change), then the use of a flow meter is recommended along with the Proportional Mode (next Run Mode).

Default settings: 12.5% dose solution concentration
 1.25 dose solution Specific Gravity
 10 LPM (liters per minute) fluid volume to be treated
 1.0 Parts Per Million to dose

Press MODE button until **Manual Dosing** is displayed in the top line of the display.

To configure the pump, navigate to **Manual Dosing** menu by using the short-cut method described at the beginning of the section, or by pressing MENU button, then selecting Input Setup, Input Modes, and then **Manual Dosing**.

Press UP or DOWN arrow to scroll through 0 - 9 on selected digit.

Press RIGHT arrow to scroll over to next digit to the right. If you pass your desired digit, you can easily scroll back by continuously pressing RIGHT button.

Press ENTER to save the changes.

Continue this process until all four screens have been configured.

If you used the short-cut to enter Manual Dosing setup, press and hold Mode button until Run Mode screen is displayed.

If you used the Menu button to navigate to Manual Dosing setup, you must navigate back out of menu structure. To do this you must select <-Esc at bottom of every screen menu until you see Run Mode screen displayed.

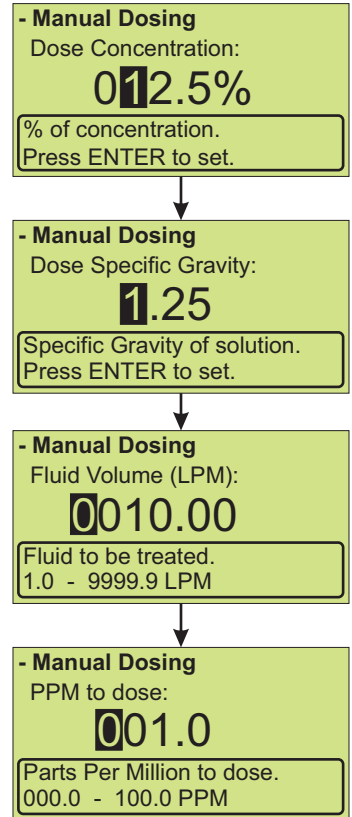

Tip! While in the Manual Dosing mode, you can view the pump settings by pressing RIGHT arrow.

Manual Dosing	
% Concentration:	12.5
Spec. Gravity:	1.25

4.3.9 Proportional Dosing

Used to configure proportional Parts Per Million dosing to a system. This method of proportional dosing is based off an input signal the pump is receiving from an external flow meter. The flow meter must have a high speed pulse output >10Hz. You will need to refer to flow meter instruction manual to obtain the K-factor for the flow meter.

Default settings: 12.5% dose solution concentration
 1.25 dose solution Specific Gravity
 5.0 K-factor (Pulses Per Liter), see flow meter instruction manual
 1.0 Parts Per Million to dose

Press MODE button until **Proportional Dosing** is displayed in the top line of the display.

To configure the pump, navigate to **Proportional Dosing** menu by using the short-cut method described at the beginning of the section, or by pressing MENU button, then selecting Input Setup, Input Modes, and then **Proportional**.

Press UP or DOWN arrow to scroll through 0 - 9 on selected digit.

Press RIGHT arrow to scroll over to next digit to the right. If you pass your desired digit, you can easily scroll back by continuously pressing RIGHT button.

Press ENTER to save the changes.

Continue this process until all four screens have been configured.

If you used the short-cut to enter Proportional Dosing setup, press and hold Mode button until Run Mode screen is displayed.

If you used the Menu button to navigate to Proportional Dosing setup, you must navigate back out of menu structure. To do this you must select <-Esc at bottom of every screen menu until you see Run Mode screen displayed.

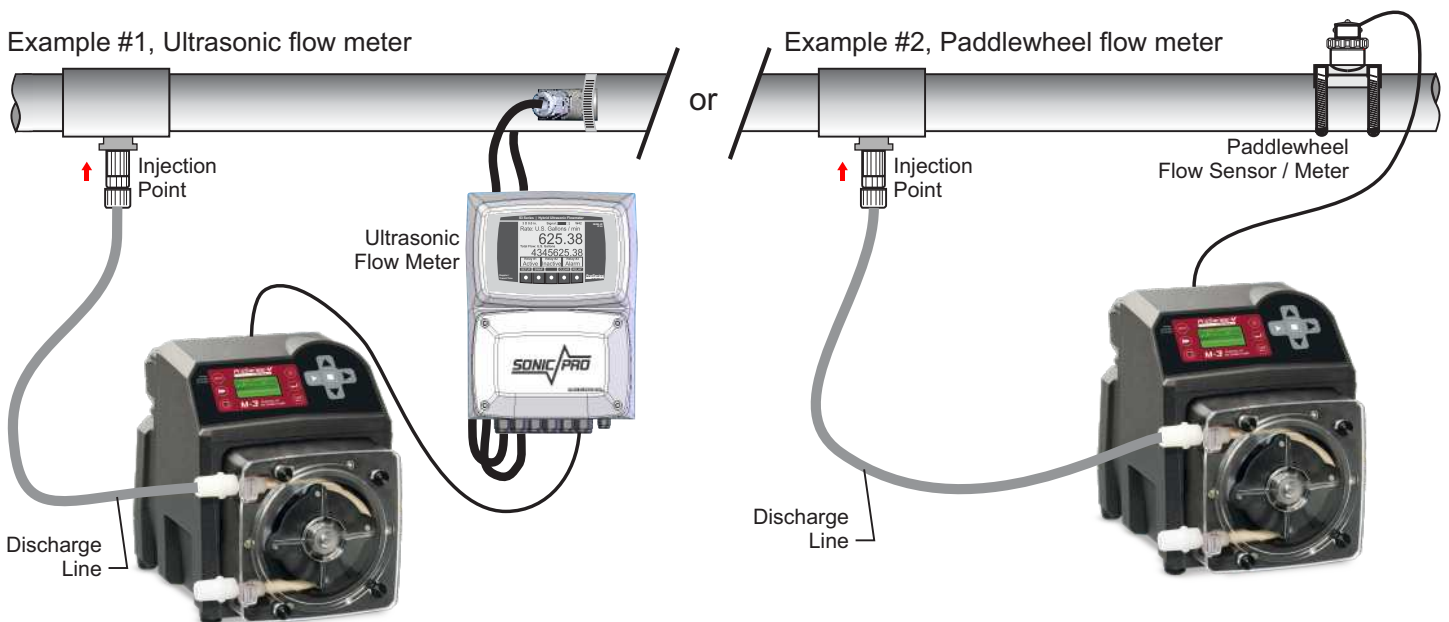
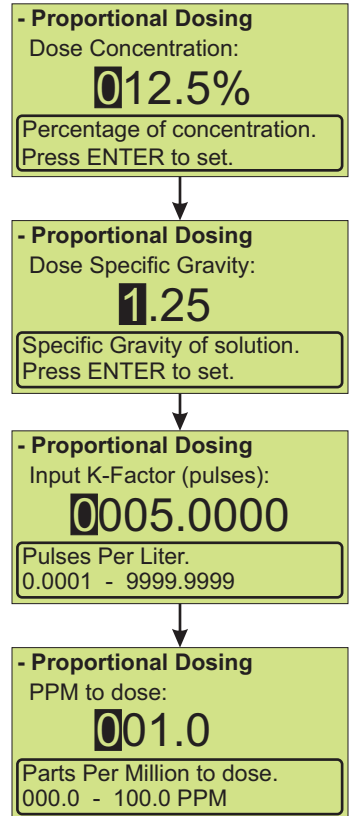

4.4 Contact Closure Input (Remote Start/Stop)

Used to remotely start and stop the pump using a close=stop or open=stop signal. If the pump must start when the loop is open, then select "Close: Stop Pump" option. Can be used with an external foot pedal, a PLC, contact closure, or other similar external devices.

Default settings: Disable

CC Input Range: 6 - 30 VDC
 or
 Dry Contact Closure (no voltage required)
 [See section 5.1 for wire connections]

Navigate to **Contact Input** menu by MENU button, then selecting Input Setup, and then **Contact Input**.

Press UP or DOWN arrow to scroll through your options.

Press ENTER to make a selection. You should then notice the radio button (square box) is now filled in next to your selection.

Press DOWN arrow to scroll down to Done selection. Then press ENTER.

To prevent false triggering due to flickering (high speed) electrical switches, a trigger delay time can be configured to delay the pump command. The delay time unit of measure is seconds. A two second delay time is recommended.

To navigate back out of menus, select <-Esc and press the ENTER button at the bottom of every screen menu until you see the Run Mode screen displayed.

IMPORTANT: To begin operation, press the START button to place pump in STANDBY. The display background will turn blue indicating the pump has been stopped remotely. When the pump is started by the remote contact, the display background will turn green.

IMPORTANT: If the Contact Closure Input is enabled, the pump will display STANDBY if the pump has been stopped by the Remote Contact Closure. **Please use caution in this mode as the pump may Start at anytime. If you must perform maintenance to the pump, Press STOP button.**

When Contact Closure Input is enabled, the word **Remote** will always be displayed on the lower left side of the display screen.

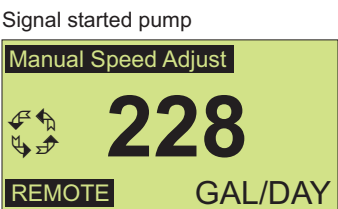
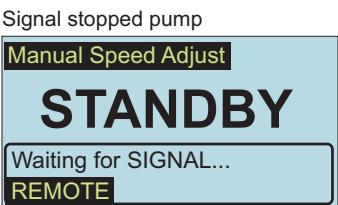
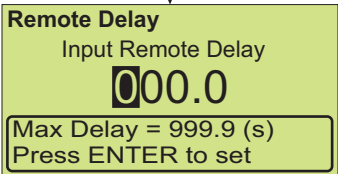
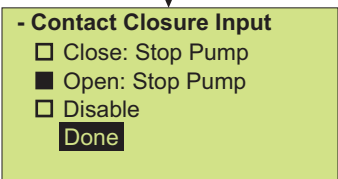
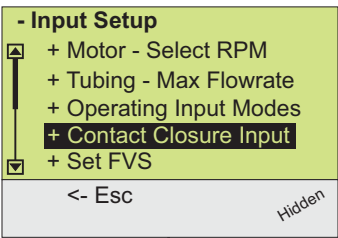
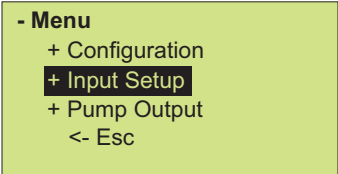

4.5 Set FVS (Flow Verification System)

Used to monitor the pump fluid output. If the pump does not dispense fluid when pump head rotor is turning, the pump will go into an alarm mode and stop. Blue-White offers a flow verification sensor that easily attaches to the inlet fitting of the pump.

Default settings: 000 (off)

Navigate to **Set FVS** menu by pressing MENU button, then selecting Input Setup, and then **Set FVS**.

Press UP or DOWN arrow to scroll through 0 - 9 on selected digit.

Press RIGHT arrow to scroll over to the next digit to right. If you pass your desired digit, you can easily scroll back by continuously pressing RIGHT button.

Press ENTER to save the changes and exit FVS screen.

To navigate back out of menus, select <-Esc and press ENTER button at the bottom of every screen menu until you see the Run Mode screen displayed.

Flow Verification System (sensor sold separately)

ProSeries-M pumps are equipped with a *Flow Verification System* which is designed to stop pump and provide a contact closure output (setup in software) in the event the sensor does not detect chemical during pump operation. This could indicate a clogged injection fitting, empty chemical solution tank, worn pump tube, loose tubing connection, etc.

To allow the pump to clear any gasses that may have accumulated during stopper operation (such as with chlorine), an alarm delay time value from 1-255 seconds must be programmed (an alarm delay value of 000 seconds disables FVS system).

If a FVS alarm occurs, the pump will stop, send an external signal (if setup), and the screen will flash FVS with an alarm icon. To clear the FVS alarm, you must press the START button or re-cycle the input power (unplug power to pump, then plug back in).

Install FVS Flow Sensor - The Flow Verification Sensor (FVS) should be installed on the inlet (suction) side of the pump tube. Sensor can be purchased with connections for 3/8" OD x 1/4" ID pump tube inlet adapter for type "S" pump tube assemblies or 1/2"F/NPT adapter designed to thread onto type "M" pump tube assemblies.

Confirm the FVS flow range - Flow Verification Sensor (FVS) will only function within its operating range. Sensor model FV-100 has an operating range of 30-300 ml/min (1-10 oz/min) when used as a flowmeter. However, due to pressure drop across the sensor, the pump's suction capability is limited to 14.7 psi. Therefore, when used with the peristaltic pump as a flow verification sensor, the effective operating range is reduced to 30-200 ml/min. Note that if the pump's output is less than 30 ml/min, the sensor will not detect chemical and a signal will not be sent to pump.

SENSOR MODEL NUMBER	PUBLISHED FLOW RANGE (ml/min)	ACTUAL WORKING RANGE WITH FLEX-PRO PUMP (ml/min)
FV-100	30-300	30-200
FV-200	100-1000	50-900
FV-300	200-2000	100-1800
FV-400	300-3000	300-3000
FV-500	500-5000	500-5000
FV-600	700-7000	700-7000

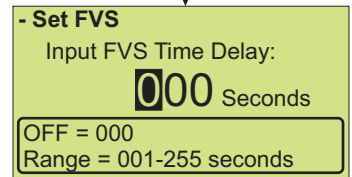
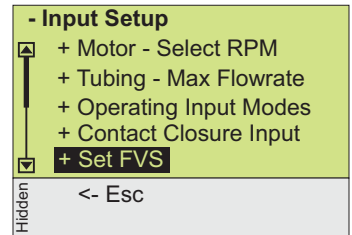

When a FVS alarm occurs

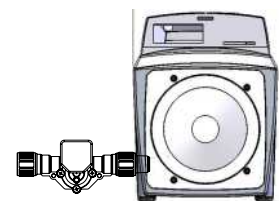

4.6 TFD (Tube Failure Detection)

Flex-Pro is equipped with a *Tube Failure Detection* System which is designed to stop the pump and provide an output alarm (see Output menu) in the event pump tube should rupture and chemical enters the pump head. At the default adjustment setting of 75%, the pump will detect a chemical with a conductivity reading greater than 500 microsiemens. The system sensitivity can be increased to 100%, reducing the conductivity to 430 microsiemens. Chemicals with a conductivity of less than 430 microsiemens will not be detected.

This patented system is capable of detecting the presence of a large number of chemicals including Sodium Hypochlorite (Chlorine), Hydrochloric (muriatic) Acid, Sodium Hydroxide, and many others. The system will not be triggered by water (rain, condensation, etc.) or silicone oil (roller and tubing lubricant).

If system has detected chemical, pump tube must be replaced and pump head and roller assembly must be thoroughly cleaned. Failure to clean the roller assembly will void warranty.

If TFD alarm occurs, pump will stop, close an alarm output (if configured), and screen will flash TFD with an alarm icon.

Confirm Chemical Detection - To determine if your chemical will be detected by the system, remove the pump head cover and the pump tube and roller assembly. Place a small amount of chemical in the bottom of the pump head - just enough to cover the sensors. Replace the pump head cover only. When asked if the tube was replaced, select "no" and press enter. Turn on the pump (press start). If the TFD system detects the chemical, the pump will stop after a two second confirmation period and the TFD Alarm screen will display. If the TFD system does not detect the chemical, the pump will continue to run after the confirmation period. Carefully clean the chemical out of the pump head being sure to remove all traces of the chemical from sensor probes. Replace the roller assembly and tubing. Replace the pump head cover. Press the START button to clear the alarm condition and restart the pump.

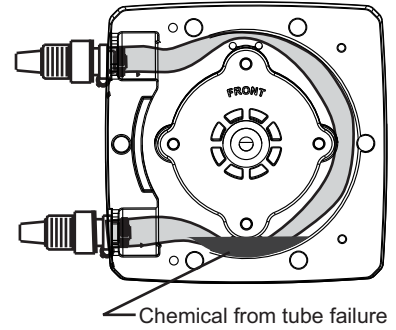

When a TFD alarm occurs



4.6.1 TFD Adjustment

Flex-Pro's patented Tube Failure Detection (TFD) system is designed to detect chemical sensitivity can be adjusted through the menu. Default setting (75% sensitivity) will trigger an alarm with most water treatment chemicals with no false triggering.

TFD sensitivity range = 75% (500 microsiemens) to 100% (430 microsiemens)

To set TFD sensitivity, press ENTER when INPUT SETUP is highlighted. Scroll down and highlight SET TFD and press ENTER

To increase sensitivity, press UP arrow.

To decrease sensitivity, press DOWN arrow.

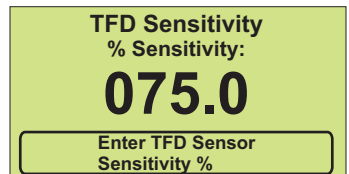
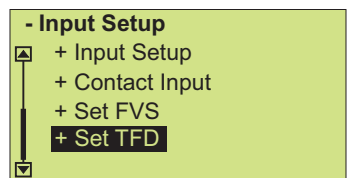
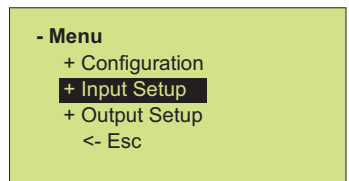

It is recommended to leave default setting at 75% sensitivity. This will eliminate your chance of false triggers. **Only** increase sensitivity if the solution your pumping does not trigger the TFD alarm at 75% sensitivity.

4.7 Remote/Local Control

The Flex-Pro can be configured for Remote control only, Local control only, or either (disabled).

When set for Remote control only, all touch pad buttons except the menu button are disabled. To completely lock out the menu, configure a password (see page 12, section 8). If REMOTE ONLY is selected, the user is prompted to select an input operating mode which must then be used when operating the pump.

When set for local control only, all input signals including the remote start/stop are disabled. Note that the “contact closure input” menu setting (section 4.4) is switched to “disabled” while **LOCAL ONLY** is selected. This menu setting will return to the previous setting when **REMOTE ONLY** or **DISABLED** is selected.

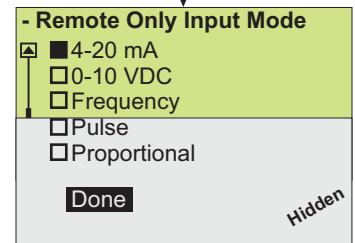
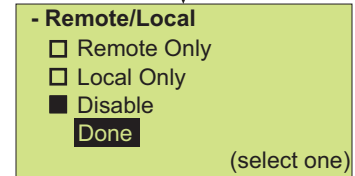
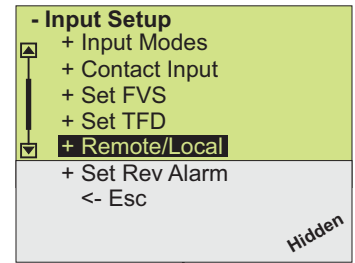

Tip! Removing the pump head cover automatically puts the pump into “maintenance” mode, allowing the operator to replace the pump tube without changing the Remote/Local settings.

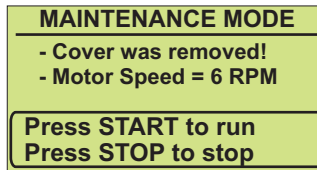

4.8 Set Revolution Alarm

One of the primary factors effecting tube life is the number of revolutions the tube has operated. The Flex-Pro includes a roller revolution counter. A revolution alarm set point can be input which will alert the user when the tube should be serviced.

When the set point is reached, the pump display will turn red and the words “REV ALARM” will be displayed. **The pump will not stop.**

An alarm output can be configured to close when the revolution set point is reached. See section 10.0 Output Setup.

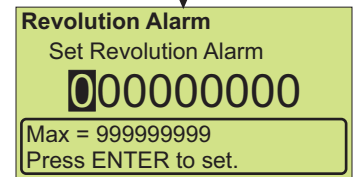
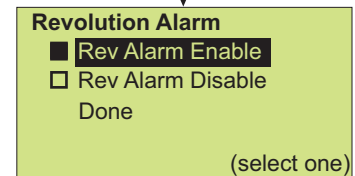
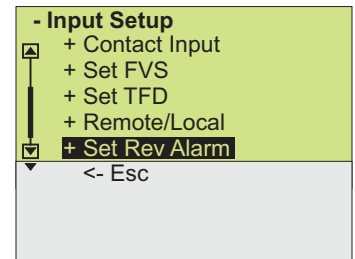

5.0 Output Setup (alarm relays)

Below is the menu structure for the Output Setup selection. The layout of the Output Setup menu is similar to the Input Setup menu. Outputs were designed to directly communicate to SCADA systems, alarms, data loggers, backup pumps, pumps to operate in sync, pumps to operate proportionally, and other external devices.

To prevent false alarms due to pump start-up and closed loop applications, a trigger delay time can be configured to delay the relay switch action. The delay time unit of measure is seconds.

5.0 Output Setup (alarm relays)

- Menu
 + Configuration
 + Input Setup
+ Output Setup
 + Power Fail option
 <- Esc

Note:
 Contact #1 shown only. Contact #2, and Contact #3 use the same menu items.

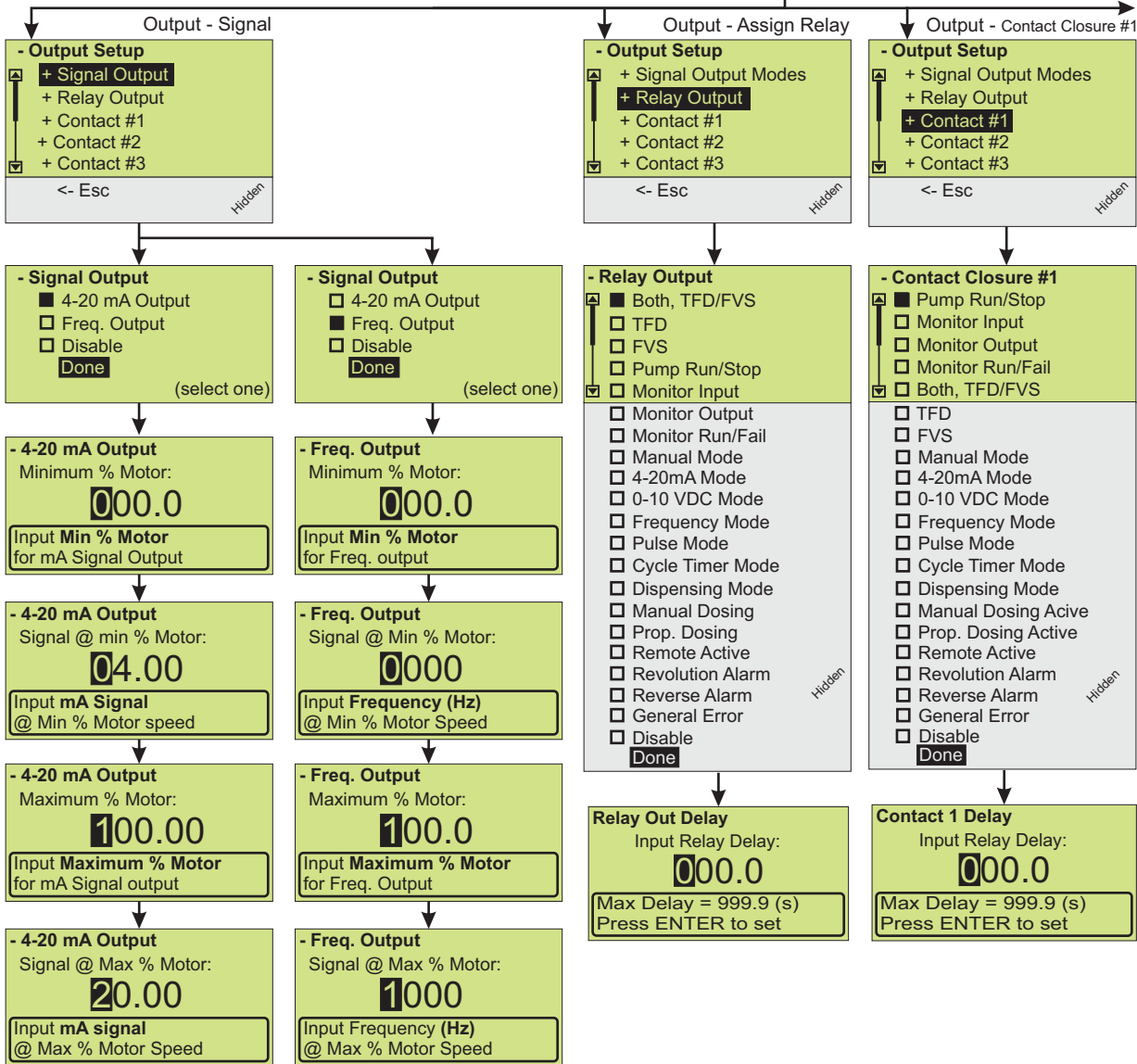

Description of Relay and Contact Closure Output triggers

Selection:

Contact energizes when:

- Pump Run/Stop*Motor turning (roller assembly is rotating).
- Monitor Input*Incoming analog or digital signal is not received or out of range.
- Monitor Output*.....Outgoing analog or digital signal not transmitted or out of range.
- Monitor Run/Fail*.....Motor fails to respond to commands.
- Both TFD/FVS*.....Either TFD or FVS system triggers.
- FVS*After the programmed delay time, pulses are not received from flow sensor.
- TFD*Tube failure is detected by sensors in the head.
- Active Mode*.....Use to monitor any changes to the active (run) mode selection.
- Remote Active*Energized when Remote only is active.
- Revolution Alarm*.....Revolution count set-point has been achieved.
- Reverse Alarm*.....The motor revolution is reversed (turning clock-wise).
- General Error*.....A motor overload or other internal error has occurred.
- Disable*.....Output contact is disabled.

5.1 Signal Output

Sends a configurable 4 - 20 mA or frequency (Hz) signal to another pump or external device. This feature can be used to control other pumps (in sync / proportionally), data logging systems, and other external devices for plant automation.

Default settings: Disable

Navigate to **Signal Output** menu by pressing MENU button, then selecting Output Setup, and then **Signal Output**.

Select your desired Signal output using UP or DOWN arrows.

Press ENTER to configure the output signal.

Press UP or DOWN arrow to scroll through 0 - 9 on selected digit.

Press RIGHT arrow to scroll over to the next digit to the right. If you pass your desired digit, you can easily scroll back by continuously pressing RIGHT button.

Press ENTER to save the changes.

Continue this process until all four screens have been configured.

To navigate back out of the menu structure you must select <-Esc at bottom of every screen menu until you see Run Mode screen displayed.

Example 1

0% Pump Output = 4 mA
100 % Pump Output = 20 mA

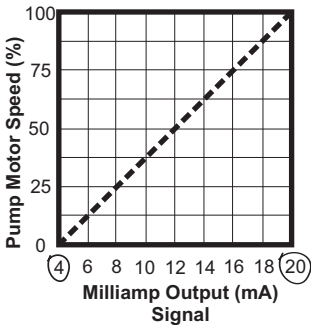

Example 2

0% Pump Output = 4 mA
50% Pump Output = 16 mA

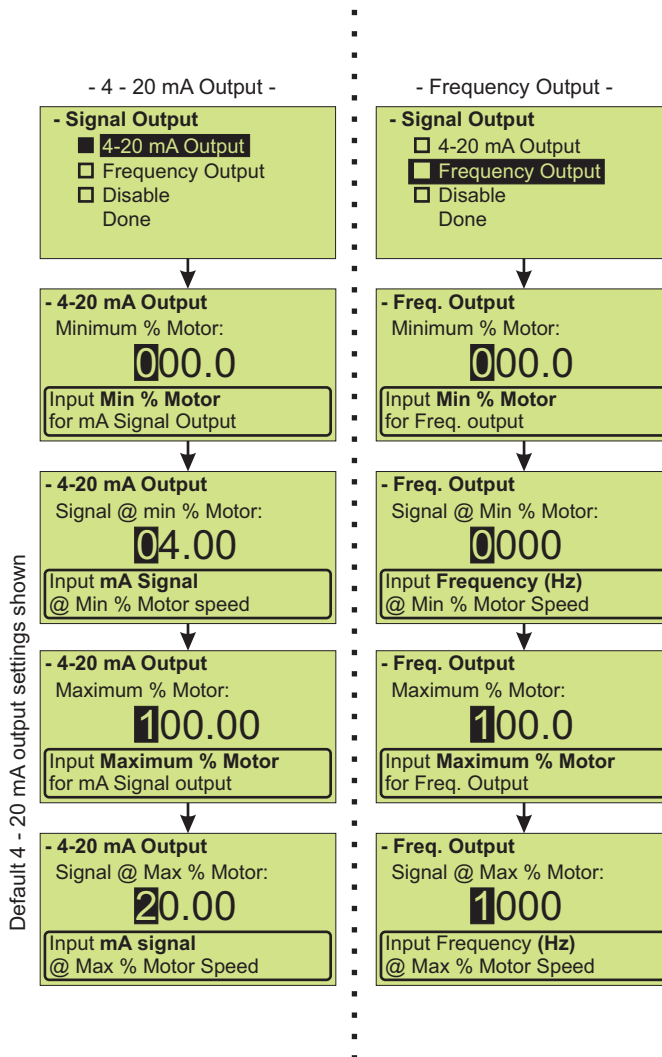
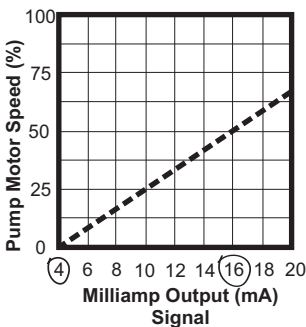

Example 1

0% Pump Output = 0 Hz
100 % Pump Output = 1000 Hz

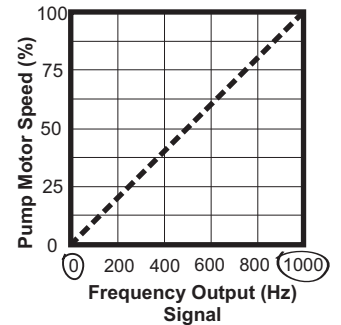

Example 2

0% Pump Output = 1000 Hz
100% Pump Output = 0 Hz

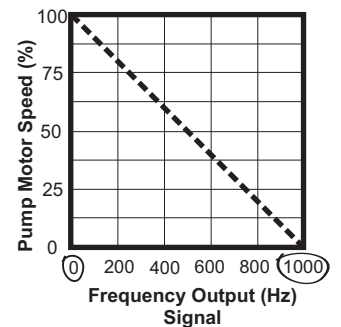

6.0 Pump Maintenance

CAUTION



Always wear protective clothing, face shield, safety glasses and gloves when working on or near your metering pump. Additional precautions should be taken depending on solution being pumped. Refer to MSDS precautions from your solution supplier.

6.1 Routine Inspection and Maintenance

The pump requires very little maintenance. However, the pump and all accessories should be checked weekly. This is especially important when pumping aggressive chemicals. Inspect all components for signs of leaking, swelling, cracking, discoloration or corrosion. Replace worn or damaged components immediately.

Cracking, crazing, discoloration and the like during first week of operation are signs of severe chemical attack. If this occurs, immediately remove chemical from pump. Determine which parts are being attacked and replace them with parts that have been manufactured using more suitable materials.

6.2 How to Clean and Lubricate the Pump

When changing the pump tube assembly, the pump head chamber, roller assembly and pump head cover should be wiped free of any dirt and debris.

100% silicon lubrication may be used on the roller assembly. Refer to www.proseries-m.com/videos for roller assembly maintenance video instructions.

Periodically clean the back flow prevention check valve assembly, especially when injecting fluids that calcify such as sodium hypochlorite. These lime deposits and other build ups can clog the fitting, increasing the back pressure at the pump (reducing tube life) and interfering with check valve operation.

The motor does not require maintenance or lubrication.

6.3 Reverse Rotor Rotation

The pump rotor can reverse rotation by pressing REVERSE ROTATION button.

In most applications, the tube will fail by developing a small leak in the outlet side (pressure side) of the tube assembly. By reversing the roller rotation, the wear point in the tube is moved to the opposite side of the pump tube assembly, increasing the life of the tube.

Reversing rotation, moves the outlet side (pressure side) to the opposite side of the tube assembly, greatly increasing the tube life.

Stop the pump before the tube failure occurs.

Disconnect power from the pump. Carefully purge any pressure in the discharge line of the pump. Disconnect the suction end tubing/piping and the discharge end tubing/piping from the pump head tubing.



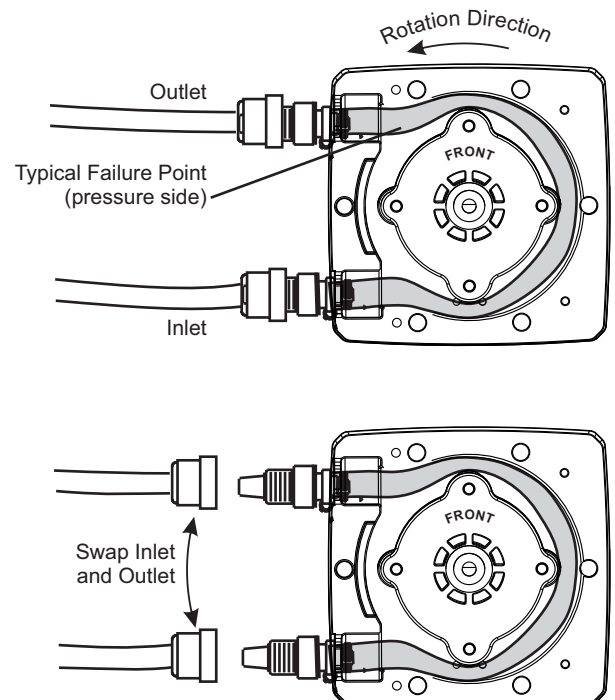

IMPORTANT! Swap sides of the suction (inlet) and discharge (outlet) tubing/piping. There is no need to remove the Pump Head Cover.

Double check all connections before starting the pump

NOTE: The pump tube will form a natural U-shaped curve. Do not attempt to install the pump tube against the natural U-shape direction as damage to the tube can result.



6.4 Tube Replacement

CAUTION 	Prior to service, pump clean water through the pump and suction / discharge line to remove chemical.
CAUTION 	Always wear protective clothing, face shield, safety glasses and gloves when working on or near your metering pump. Additional precautions should be taken depending on solution being pumped. Refer to MSDS precautions from your solution supplier.
CAUTION 	Use provided Tube Installation Tool to leverage tubing into pump head, <u>NOT YOUR FINGERS.</u>
CAUTION 	Use extreme caution when replacing pump tube. Be careful of your fingers and <u>DO NOT</u> place fingers near rollers.

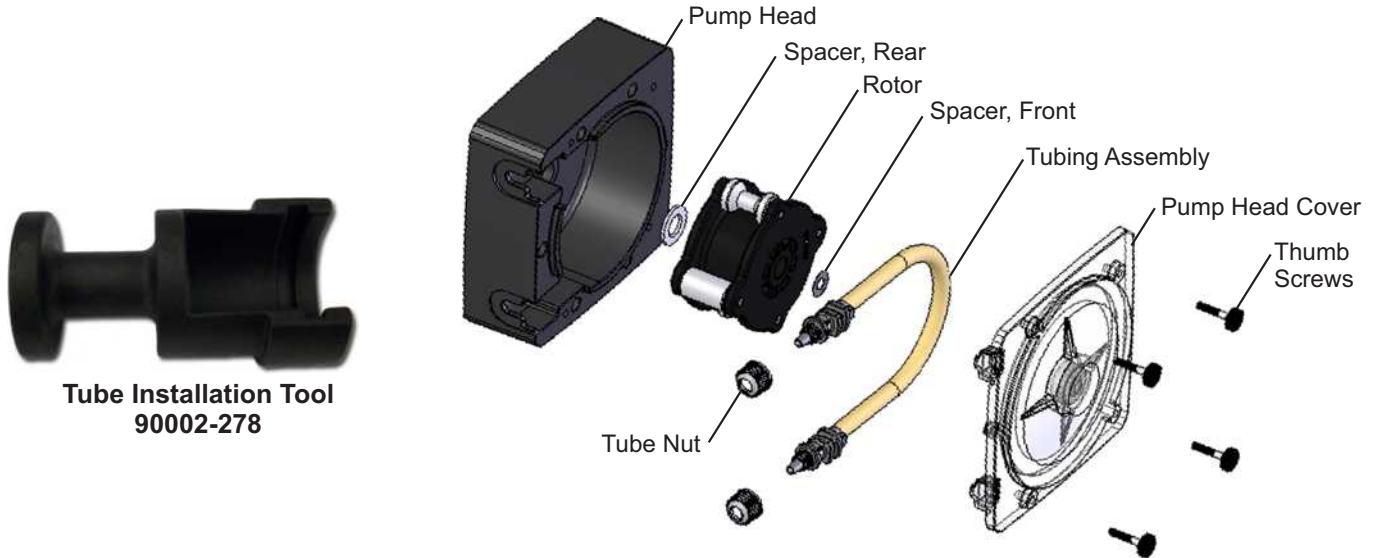

Remove the **Pump Head Cover** by unscrewing the four **Thumb Screws**. Pull out the **Pump Head Cover**.

The pump will detect that the **Pump Head Cover** is removed and enter MAINTENANCE MODE.

Rotor will rotate at a maximum of 6 RPM for your safety.

Pull out the suction side of **Tubing Assembly**.

Press the START button. While the rotor is rotating, pull out the old **Tube Assembly**.

TIP! Let the pump do the work for you. Just guide the tubing out between the two rollers located on the **Rotor**.

Press the STOP button at any time to stop the pump.

Pull out the suction line adapter from the Pump Head. Pull out the **Tubing Assembly** as the **Rotor** rotates around.

Stop the pump by pressing the STOP button.

Thoroughly clean the **Pump Head** and **Rotor**. The **Rotor** can be removed by pulling it straight out. After the cleaning process, push the **Rotor** back on the shaft. See the drawing above for proper assembly. Be sure the front and rear rotor spacers are in place. **IMPORTANT!** **Rotor** direction; the word "FRONT" on **Rotor** must face the front of the pump.

Locate your new tubing and Tube Installation Tool. See the next page to install new **Tube Assembly** into **Pump Head**.

MAINTENANCE MODE

Pump Cover Removed!

MAINTENANCE MODE

- Cover was removed!
- Motor Speed = 6 RPM

Press **START** to run
Press **STOP** to stop

TIP! Silicone lubrication may be applied to outside of Flex-A-Thane tube for longer life.



1
Insert suction fitting into pump head. Remove your fingers from pump head. Start pump by pressing START button. Grab hold of Tube Installation Tool and use it to leverage tubing into pump head.



2
Introduce tubing into pump head while the rotor is rotating. Avoid using fingers to guide the tubing. Stop pump at anytime by pressing STOP button. Start pump by pressing START button.

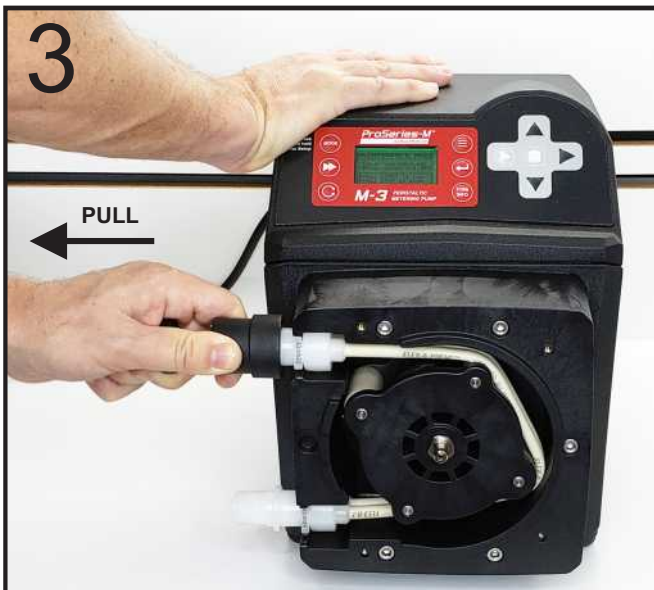

3
Continue to follow rotation of rotor while directing tube into pump head. At this point, you may need to pull Tube Installation Tool to stretch tubing into position. Let rotor spin a few rotations while pulling Installation tool so fitting can be properly installed.



4
Continue to pull Tube Installation Tool to allow enough room to slide discharge fitting into pump head tongue and groove. Once discharge fitting is secured in pump head, stop pump by pressing STOP button. Replace pump head cover. Pump will ask you if the tube was replaced, select yes. Pump will then ask if you would like to reset REV counter, select yes. REV count will display for 5 seconds before resetting to zero.

Re-attach the **Pump Head Cover** using the four **Thumb Screws**.

The pump will detect the **Pump Head Cover** is installed and begin to exit MAINTENANCE MODE.

The pump will ask you if the tube was replaced. Yes / No

If Yes is selected, the pump ask you to reset the Revolution Count. Yes / No

If Yes is selected, the pump will display the Current Revolution Count briefly (5 seconds) before resetting to zero.

The pump can now begin normal operation.

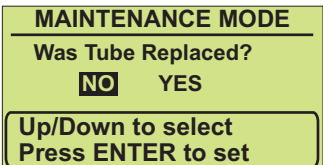
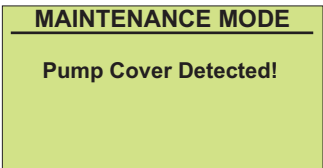

6.5 Replacement Parts List

M-3 Replacement Parts List

Peristaltic Metering Pump

Item	Description	Part Number	QTY		
2	Spacer, Back	90011-184	1		
Flex-A-Prene®	Tubing in this group are interchangeable with single roller assembly (rotor).	3	Roller Assembly Complete (Rotor), For ND Tubes	A3-SND-R	1
		4	Tube Assembly, 3/8" OD tube compression fitting, Flex-A-Prene® ND (.075 ID)	A3-SND-T	1
		4	Tube Assembly, 1/2" Male NPT connect, Flex-A-Prene® ND (.075 ID)	A3-MND-T	1
Flex-A-Prene®	Tubing in this group are interchangeable with single roller assembly (rotor).	3	Roller Assembly Complete (Rotor), For NJ, NK, NE, and NGG Tubes	A3-SNGG-R	1
		4	Tube Assembly, 3/8" OD tube compression fitting, Flex-A-Prene® NJ (.312 ID)	A3-SNJ-T	1
		4	Tube Assembly, 1/2" Male NPT connect, Flex-A-Prene® NJ (.312 ID)	A3-MNJ-T	1
		4	Tube Assembly, 3/8" OD tube compression fitting, Flex-A-Prene® NK (.375 ID)	A3-SNK-T	1
		4	Tube Assembly, 1/2" Male NPT connect, Flex-A-Prene® NK (.375 ID)	A3-MNK-T	1
		3	Roller Assembly Complete (Rotor), For NKL Tubes	A3-STH-R	1
		4	Tube Assy, 3/8" OD tube comp, Flex-A-Prene® NKL (.375 ID) Low Pressure (30 psi max)	A3-MNKL-T	1
4	Tube Assy, 1/2" Male NPT, Flex-A-Prene® NKL (.375 ID) Low Pressure (30 psi max)	A3-MNKL-T	1		
Flex-A-Prene®	Tubing in this group are interchangeable with single roller assembly (rotor).	3	Roller Assembly Complete (Rotor), For NJ, NK, NEE and NGG Tubes	A3-SNGG-R	1
		4	Tube Assembly, Quick Disconnect, Flex-A-Prene® NEE (0.093 ID)*	A3-QNEE-T	1
		4	Tube Assembly, 3/8" OD tube compression fitting, Flex-A-Prene® NEE (0.093 ID)	A3-SNEE-T	1
		4	Tube Assembly, 1/2" Male NPT, Flex-A-Prene® NEE (0.093 ID)	A3-MNEE-T	1
		4	Tube Assembly, 1/2" Hose Barb, Flex-A-Prene® NEE (0.093 ID)	A3-BNEE-T	1
		4	Tube Assembly, 1/2" - 3/4" tri-clamp (Sanitary Fitting), Flex-A-Prene® NEE (0.093 ID)	A3-CNEE-T	1
		4	Tube Assembly, Quick Disconnect, Flex-A-Prene® NGG (0.187 ID)*	A3-QNGG-T	1
		4	Tube Assembly, 3/8" OD tube compression fitting, Flex-A-Prene® NGG (0.187 ID)	A3-SNGG-T	1
		4	Tube Assembly, 1/2" Male NPT, Flex-A-Prene® NGG (0.187 ID)	A3-MNGG-T	1
		4	Tube Assembly, 1/2" Hose Barb, Flex-A-Prene® NGG (0.187 ID)	A3-BNGG-T	1
		4	Tube Assembly, 1/2" - 3/4" tri-clamp (Sanitary Fitting), Flex-A-Prene® NGG (0.187 ID)	A3-CNGG-T	1
Flex-A-Chem®	Tubing in this group are interchangeable with single roller assembly (rotor).	3	Roller Assembly Complete (Rotor), For TH Tubes	A3-STH-R	1
		4	Tube Assembly, 3/8" OD tube compression fitting, Flex-A-Chem® TH (.250 ID)	A3-STH-T	1
		4	Tube Assembly, 1/2" Male NPT, Flex-A-Chem® TH (.250 ID)	A3-MTH-T	1
		3	Roller Assembly Complete (Rotor), For TK Tubes	A3-SNGG-R	1
		4	Tube Assembly, 3/8" OD tube compression fitting, Flex-A-Chem® TK (.375 ID)	A3-STK-T	1
		4	Tube Assembly, 1/2" Male NPT, Flex-A-Chem® TK (.375 ID)	A3-MTK-T	1
Flex-A-Thane®	Tubing in this group are interchangeable with single roller assembly (rotor).	3	Roller Assembly Complete (Rotor), For GE, GG, GH, GK, G2G Tubes	A3-SGE-R	1
		4	Tube Assembly, 3/8" OD tube compression fitting, Flex-A-Thane® GE (.125 ID)	A3-SGE-T	1
		4	Tube Assembly, 1/2" Male NPT connect, Flex-A-Thane® GE (.125 ID)	A3-MGE-T	1
		4	Tube Assembly, 3/8" OD tube compression fitting, Flex-A-Thane® GG (.187 ID)	A3-SGG-T	1
		4	Tube Assembly, 1/2" Male NPT connect, Flex-A-Thane® GG (.187 ID)	A3-MGG-T	1
		4	Tube Assembly, 3/8" OD tube compression fitting, Flex-A-Thane® GH (.250 ID)	A3-SGH-T	1
		4	Tube Assembly, 1/2" Male NPT connect, Flex-A-Thane® GH (.250 ID)	A3-MGH-T	1
		4	Tube Assembly, 3/8" OD tube compression fitting, Flex-A-Thane® GK (.375 ID)	A3-SGK-T	1
		4	Tube Assembly, 1/2" Male NPT connect, Flex-A-Thane® GK (.375 ID)	A3-MGK-T	1
		4	Tube Assembly, 3/8" OD tube compression fitting, Flex-A-Thane® G2G (.187 ID)	A3-SG2G-T	1
		4	Tube Assembly, 1/2" Male NPT connect, Flex-A-Thane® G2G (.187 ID)	A3-MG2G-T	1
6	Pump Head Cover, Polycarbonate - New design, backwards compatible	A3-SXX-C	1		
7	Thumb Screw	90011-183	4		
8	Tube Nut, Compression, For 3/8" Tubing	C-330-6	2		
Not Shown	Stainless Steel mounting bracket kit (pair)	72000-379	1		
Not Shown	Stainless Steel extended mounting bracket kit (pair)	72000-380	1		
Not Shown	Rubber feet	90003-561	4		

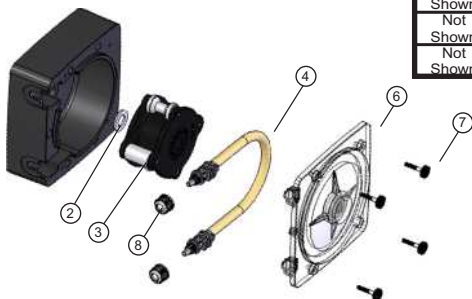

Note: ND, NKL, and G2G tube assemblies are also available in "B", "C" and "Q" connection types.

M-4 Replacement Parts List

Peristaltic Metering Pump

	Item	Description	Part Number	QTY
	2	Spacer, two spacers required, A4 (replaces 90011-184)	90011-217	1
Flex-A-Prene®	3	Roller Assy Complete (A4 Rotor), For NH, NJ, NK, NHH Tubes	A4-MNH-R	1
	4	Tube Assembly, 1/2" hose barb, Flex-A-Prene® NH (.25 ID)	A4-BNH-T	1
	4	Tube Assembly, 1/2" Male NPT, Flex-A-Prene® NH (.25 ID)	A4-MNH-T	1
	4	Tube Assembly, Quick Disconnect, Flex-A-Prene® NH (0.25 ID)*	A4-QNH-T	1
	4	Tube Assembly, 1/2" hose barb, Flex-A-Prene® NJ (.31 ID)	A4-BNJ-T	1
	4	Tube Assembly, 1/2" Male NPT, Flex-A-Prene® NJ (.31 ID)	A4-MNJ-T	1
	4	Tube Assembly, Quick Disconnect, Flex-A-Prene® NJ (0.31 ID)*	A4-QNJ-T	1
	4	Tube Assembly, 1/2" Male NPT, Flex-A-Prene® NK (0.38 ID)	A4-MNK-T	1
	4	Tube Assembly, Quick Disconnect, Flex-A-Prene® NK (0.38 ID)*	A4-QNK-T	1
	4	Tube Assembly, 1/2" Male NPT, Multi-Tube Flex-A-Prene® NHH (.25 + .25 ID)	A4-MNHH-T	1
	4	Tube Assembly, 1/2" Male NPT, Multi-Tube Flex-A-Prene® NHH (.25 + .25 ID)	A4-MNHH-T	1
Flex-A-Prene®	3	Roller Assy Complete (A4 Rotor), For NL, NP Tubes	A4-MNL-R	1
	4	Tube Assembly, 1/2" hose barb, Flex-A-Prene® NL (.50 ID)	A4-BNL-T	1
	4	Tube Assembly, 1/2" Male NPT, Flex-A-Prene® NL (.50 ID)	A4-MNL-T	1
	4	Tube Assembly, Quick Disconnect, Flex-A-Prene® NL (.50 ID)*	A4-QNL-T	1
	4	Tube Assembly, 1/2" hose barb, Flex-A-Prene® NP (.75 ID)	A4-BNP-T	1
	4	Tube Assembly, 1/2" Male NPT, Flex-A-Prene® NP (.75 ID)	A4-MNP-T	1
	4	Tube Assembly, Quick Disconnect, Flex-A-Prene® NP (.75 ID)*	A4-QNP-T	1
Flex-A-Chem®	3	Roller Assy Complete (A4 Rotor), For TH, TK, THH, TTK Tubes	A4-MTH-R	1
	4	Tube Assembly, 1/2" hose barb, Flex-A-Chem® TK (.38 ID)	A4-BTK-T	1
	4	Tube Assembly, 1/2" Male NPT, Flex-A-Chem® TK (.38 ID)	A4-MTK-T	1
	4	Tube Assy, 1/2" hose barb, Multi-Tube Flex-A-Chem® TK & TK (.38 + .38 ID)	A4-BTKK-T	1
	4	Tube Assy, 1/2" Male NPT, Multi-Tube Flex-A-Chem® TK & TK (.38 + .38 ID)	A4-MTKK-T	1
Flex-A-Thane®	3	Roller Assy Complete (A4 Rotor), For GH, GK, GHH, GKK Tubes	A4-MGH-R	1
	4	Tube Assembly, 1/2" hose barb, Flex-A-Thane® GH (.25 ID)	A4-BGH-T	1
	4	Tube Assembly, 1/2" Male NPT, Flex-A-Thane® GH (.25 ID)	A4-MGH-T	1
	4	Tube Assembly, 1/2" hose barb, Flex-A-Thane® GK (.38 ID)	A4-BGK-T	1
	4	Tube Assembly, 1/2" Male NPT, Flex-A-Thane® GK (.38 ID)	A4-MGK-T	1
	4	Tube Assy, 1/2" hose barb, Multi-Tube Flex-A-Thane® GH & GH (.25 + .25 ID)	A4-BGHH-T	1
	4	Tube Assy, 1/2" Male NPT, Multi-Tube Flex-A-Thane® GH & GH (.25 + .25 ID)	A4-MGHH-T	1
	4	Tube Assy, 1/2" hose barb, Multi-Tube Flex-A-Thane® GK & GK (.38 + .38 ID)	A4-BGKK-T	1
	4	Tube Assy, 1/2" Male NPT, Multi-Tube Flex-A-Thane® GK & GK (.38 + .38 ID)	A4-MGKK-T	1
Not Shown		Stainless Steel mounting bracket kit (pair)	72000-379	1
Not Shown		Stainless Steel extended mounting bracket kit (pair)	72000-380	1
Not Shown		Rubber feet (4 required per pump, sold individually)	90003-561	1

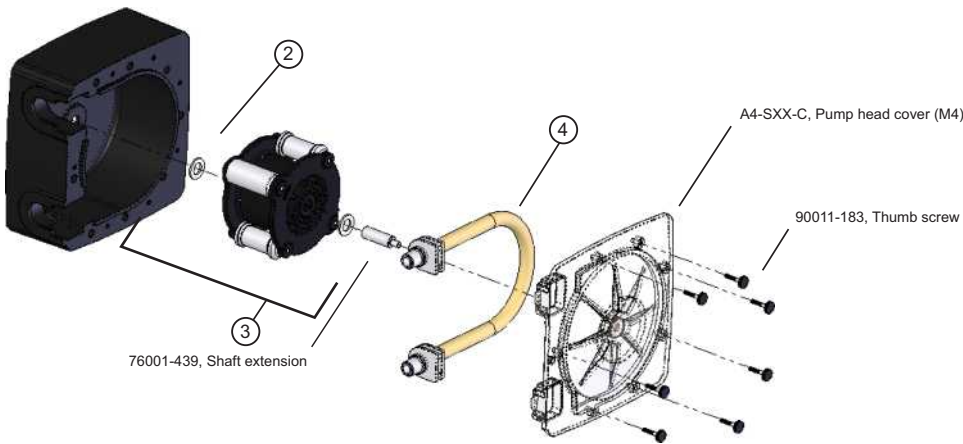

7.1 Output Versus Fluid Viscosity

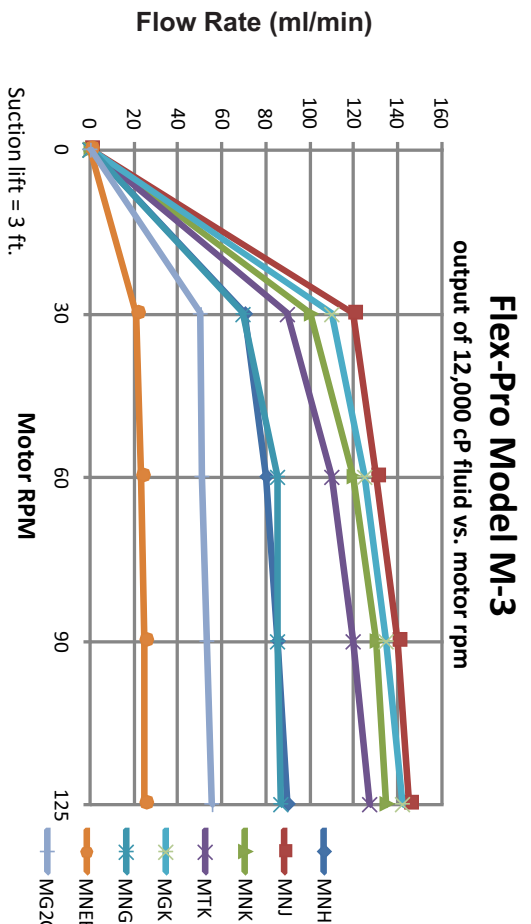
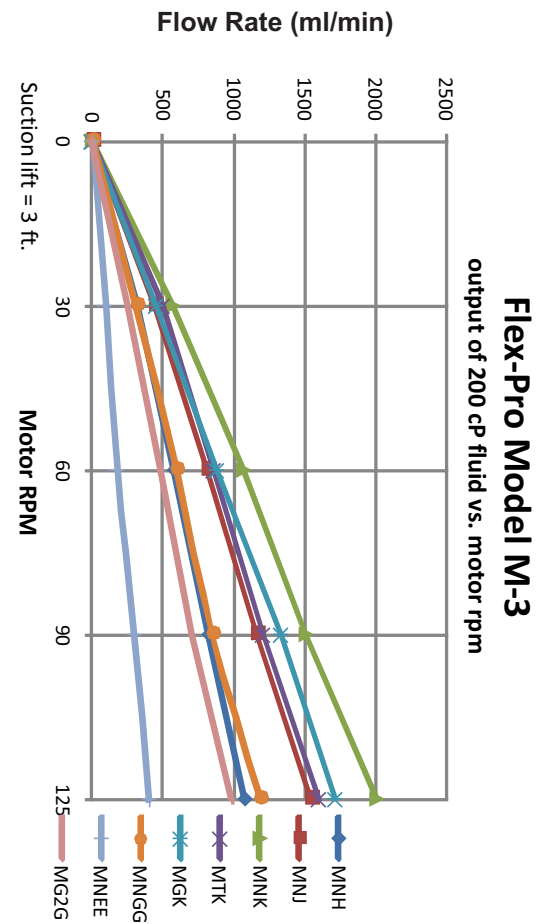
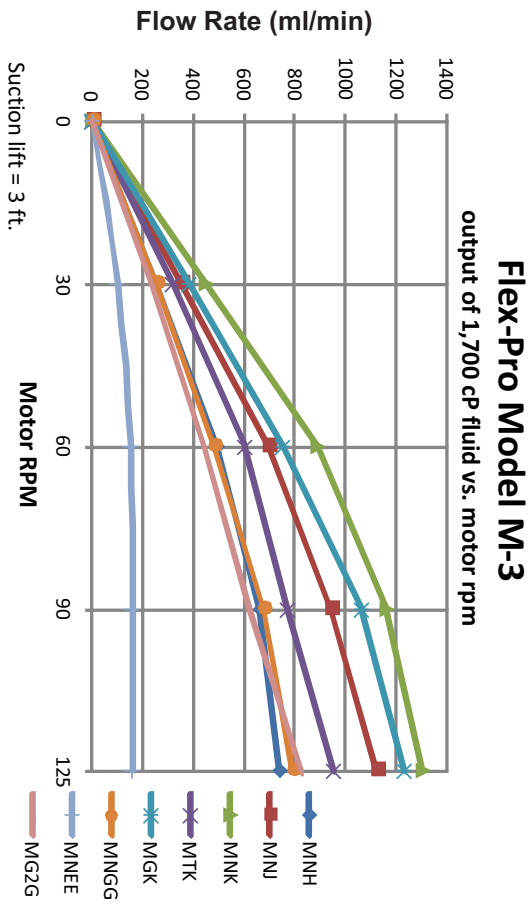
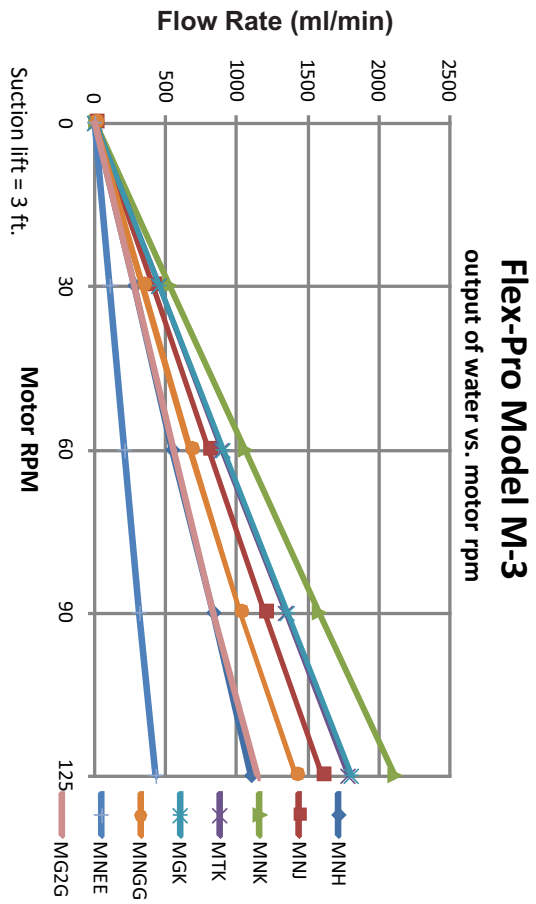

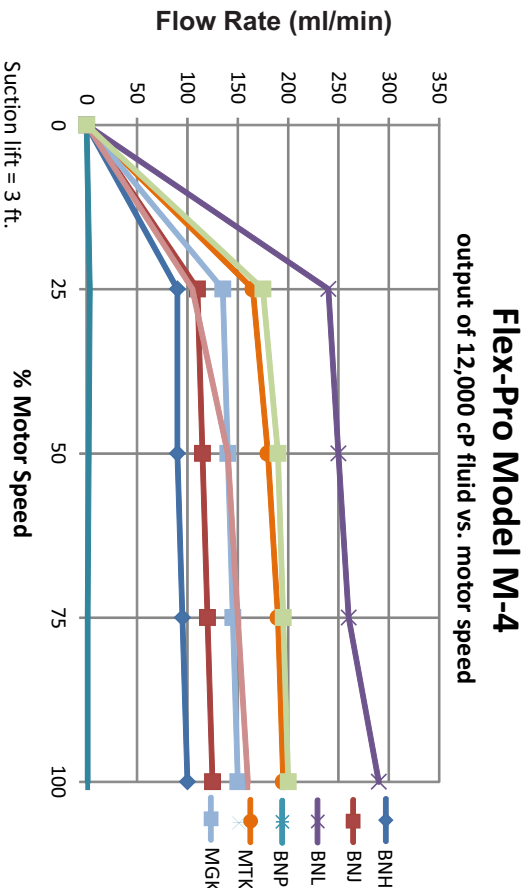
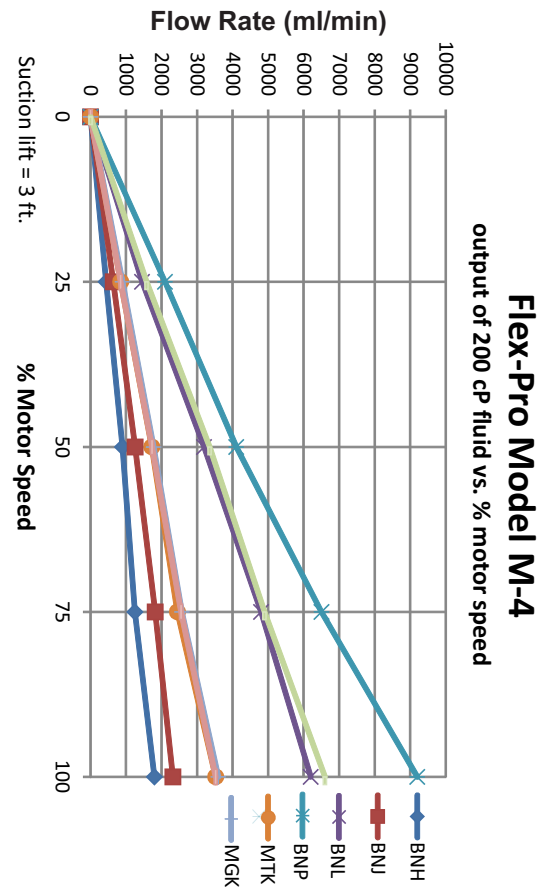
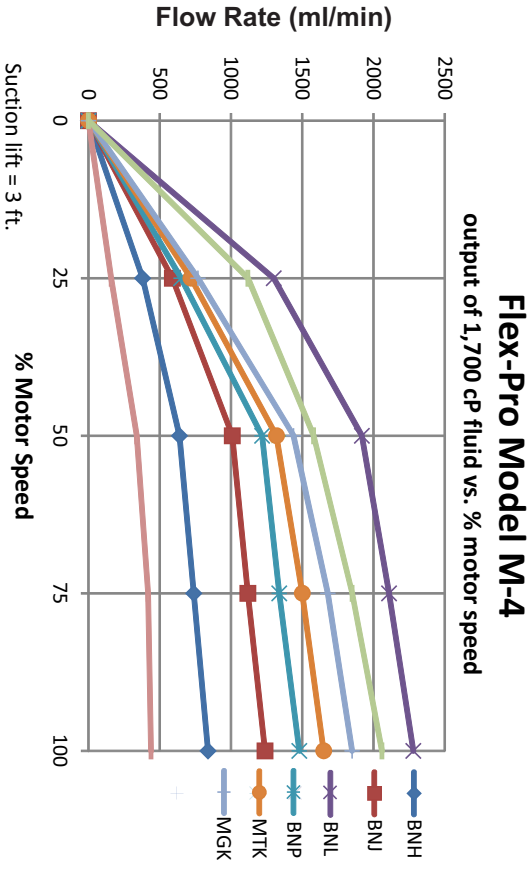
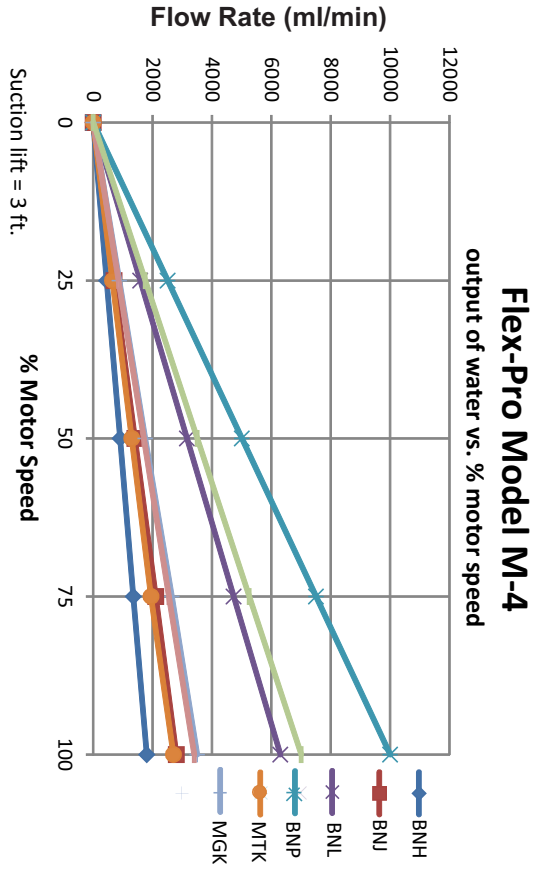

Intentionally Left Blank

Intentionally Left Blank

LIMITED WARRANTY

Your new Flex-Pro pump is a quality product and is warranted for 5 years from date of purchase (proof of purchase is required). The pump will be repaired or replaced at our discretion. Pump Head and roller assembly is warranted for 2 years against damage from chemical attack when proper TFD (Tube Failure Detection) system instructions and maintenance procedures are followed.

WHAT IS NOT COVERED

- **Pump Tube Assemblies and rubber components – They are perishable and require periodic replacement.**
- **Pump removal, or re-installation, and any related labor charge.**
- **Freight to the factory, or ProSeries service center.**
- **Pumps that have been tampered with, or in pieces.**
- **Damage to the pump resulting from misuse, carelessness such as chemical spills on the enclosure, abuse, lack of maintenance, or alteration which is out of our control.**
- **Pumps damaged by faulty wiring, power surges or acts of nature.**

Blue-White Industries does not assume responsibility for any loss, damage, or expense directly or indirectly related to or arising out of the use of its products. Failure must have occurred due to defect in material or workmanship and not as a result of operation of the product other than in normal operation as defined in the pump manual.

Warranty status is determined by the pump's serial label and the sales invoice or receipt. The serial label must be on the pump and legible. The warranty status of the pump will be verified by Blue-White or a factory authorized service center.

OTHER IMPORTANT WARRANTY INFORMATION

Blue-White injectors are factory tested with water only for pressure and performance. Installers and operators of these devices must be well informed and aware of the precautions to be taken when injecting various chemicals - especially those considered hazardous or dangerous. Eye protection must be worn when working around this product or any other metering type of pump.

Should it become necessary to return the pump for repair or service, you must attach information regarding the chemical used as some residue may be present within the unit which could be a hazard to service personnel. Blue-White Industries will not be liable for any damage that may result by the use of chemicals with their injectors and its components.

PROCEDURE FOR IN WARRANTY REPAIR

Carefully pack the pump to be repaired. It is recommended to include foot strainer and injection/check valve fitting since these devices may be clogged and part of the problem. Please enclose a brief description of the problem as well as the original invoice or sales receipt, or copy showing the date of purchase. Prepay all shipping costs. No COD shipments they will not be accepted. Warranty service must be performed by the factory or an authorized ProSeries service center. Damage caused by improper packaging is the responsibility of the sender. When In-Warranty repair or replacement is completed, the factory pays for return shipping to the dealer or customer.



Users of electrical and electronic equipment (EEE) with the WEEE marking per Annex IV of the WEEE Directive must not dispose of end of life EEE as unsorted municipal waste, but use the collection framework available to them for the return, recycle, recovery of WEEE and minimize any potential effects of EEE on the environment and human health due to the presence of hazardous substances. The WEEE marking applies only to countries within the European Union (EU) and Norway. Appliances are labeled in accordance with European Directive 2002/96/EC.

Contact your local waste recovery agency for a *Designated Collection Facility* in your area.