

EOM

ENGINEERING OPERATION
& MAINTENANCE

P25 Bolted Plastic Pump



Where Innovation Flows

WILDEN®

WIL-11020-E-03

Contents

Section 1: Precautions - Read First!	4
Section 2: Wilden Pump Designation System	5
Section 3: How It Works—Pump & Air Distribution System	6
Section 4: Dimensional Drawings	7
P25 Advanced™ Plastic PTFE -Fitted.....	7
Section 5: Performance	8
P25 Advanced™ Plastic PTFE -Fitted.....	8
Suction-Lift Curves.....	9
Section 6: Suggested Installation, Operation, Maintenance and Troubleshooting	10
Section 7: Disassembly / Reassembly	13
Pump Disassembly.....	13
Air Valve / Center Section Disassembly.....	16
Reassembly Hints & Tips.....	18
Section 8: Exploded View and Parts List	20
P25 Advanced™ Plastic PTFE-Fitted.....	20
Section 9: Elastomer Options	22

Copyright

Copyright 2018 PSG[®], a Dover Company. All rights reserved.

PSG reserves the right to modify the information and illustrations in this document without prior notice. The product described in this document is furnished under a license agreement or nondisclosure agreement. No part of this document may be reproduced, stored in a retrieval system, or transmitted in any form or any means electronic or mechanical, including photocopying and recording, without the written permission of PSG, a Dover Company, except as described by the terms of those agreements.

This is a non-contractual document. 01-2019.

Trademarks

PSG and the PSG logo are registered trademarks of PSG. Wilden[®] is a registered trademark of PSG California LLC. Pro-Flo[®] SHIFT and Pro-Flo[®] are registered trademarks of PSG California LLC. Wil-Flex[®] is a trademark of PSG California LLC. Saniflex[™] is a trademark of PSG California LLC.

All trademarks, names, logos and service marks (collectively "trademarks") in this document are registered and unregistered trademarks of their respective owners. Nothing contained in this document should be construed as granting any license or right to use any trademark without the prior written permission of the trademark owner.

Warranty

Each and every product manufactured by Wilden is built to meet the highest standards of quality. Every pump is functionally tested to insure integrity of operation. Wilden warrants that pumps, accessories and parts manufactured or supplied by it to be free from defects in material and workmanship for a period of five (5) years from date of installation or six (6) years from date of manufacture, whichever comes first.

For more information, and to register your Wilden pump for warranty, please visit <https://www.psgdover.com/wilden/support/warranty-registration>.

Certifications



Section 1

Precautions - Read First!

 **CAUTION:** Do not apply compressed air to the exhaust port — pump will not function

 **CAUTION:** Do not over-lubricate air supply — excess lubrication will reduce pump performance. Pump is pre-lubed

 **TEMPERATURE LIMITS*:**

Polypropylene	0°C to 79.4°C	32°F to 175°F
PVDF	-12.2°C to 107.2°C	10°F to 225°F
Neoprene	-17.8°C to 93.3°C	0°F to 200°F
Buna-N	-12.2°C to 82.2°C	10°F to 180°F
EPDM	-51.1°C to 137.8°C	-60°F to 280°F
FKM	-40°C to 176.7°C	-40°F to 350°F
Wil-Flex™	-40°C to 107.2°C	-40°F to 225°F
Saniflex™	-28.9°C to 104.4°C	-20°F to 220°F
Polyurethane	-12.2°C to 65.6°C	10°F to 150°F
Tetra-Flex™ PTFE w/Neoprene Backed	4.4°C to 107.2°C	40°F to 225°F
Tetra-Flex™ PTFE w/EPDM Backed	-10°C to 137.8°C	14°F to 280°F
PTFE	4.4°C to 104.4°C	40°F to 220°F

NOTE: Not all materials are available for all models. Refer to Section 2 for material options for your pump.

 **CAUTION:** When choosing pump materials, be sure to check the temperature limits for all wetted components. Example: FKM has a maximum limit of 176.7°C (350°F) but polypropylene has a maximum limit of only 79.4°C (175°F).

 **CAUTION:** Maximum temperature limits are based upon mechanical stress only. Certain chemicals will significantly reduce maximum safe operating temperatures. Consult Chemical Resistance Guide (E4) for chemical compatibility and temperature limits.

 **WARNING:** Prevention of static sparking — If static sparking occurs, fire or explosion could result. Pump, valves, and containers must be grounded to a proper grounding point when handling flammable fluids and whenever discharge of static electricity is a hazard.

 **CAUTION:** Do not exceed 8.6 bar (125 psig) air supply pressure.

 **CAUTION:** The process fluid and cleaning fluids must be chemically compatible with all wetted pump components (see E4).

 **CAUTION:** Pumps should be thoroughly flushed before installing into process lines. FDA and USDA approved pumps should be cleaned and/ or sanitized before being used.

 **CAUTION:** Always wear safety glasses when operating pump. If diaphragm rupture occurs, material being pumped may be forced out air exhaust.

 **CAUTION:** Before any maintenance or repair is attempted, the compressed air line to the pump should be disconnected and all air pressure allowed to bleed from pump. Disconnect all intake, discharge and air lines. Drain the pump by turning it upside down and allowing any fluid to flow into a suitable container

 **CAUTION :** Blow out air line for 10 to 20 seconds before attaching to pump to make sure all pipeline debris is clear. Use an in-line air filter. A 5µ (micron) air filter is recommended

 **NOTE:** Before starting disassembly, mark a line from each liquid chamber to its corresponding air chamber. This line will assist in proper alignment during reassembly.

 **CAUTION:** Pro-Flo® pumps cannot be used in submersible applications. Pro-Flo V™ is available in both submersible and non-submersible options. Do not use non-submersible Pro-Flo V™ models in submersible applications. Turbo-Flo™ pumps can be used in submersible applications.

 **CAUTION:** Tighten all hardware prior to installation.

Section 2

WILDEN PUMP DESIGNATION SYSTEM

P25 PLASTIC

6 mm (1/4") Pump
Maximum Flow Rate:
16.7 lpm (4.4 gpm)

LEGEND

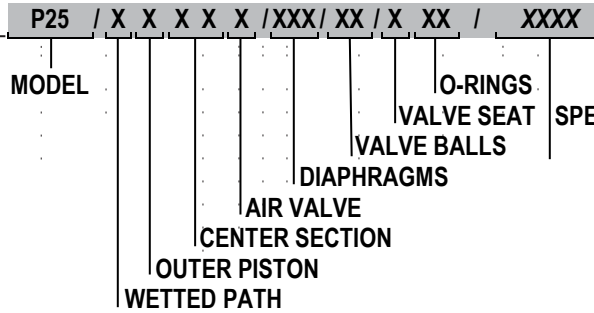

MATERIAL CODES

MODEL
P25 = PRO-FLO®

WETTED PATH
P = POLYPROPYLENE
K = PVDF

OUTER PISTON
Z = NO OUTER PISTON

CENTER BLOCK
PP = POLYPROPYLENE

AIR VALVE
P = POLYPROPYLENE

DIAPHRAGMS
TNL = PTFE W/NEOPRENE
BACK-UP O-RING, IPD
(White)
TNU = PTFE W/NEOPRENE
BACK-UP (White)
VTS = FKM (White Dot)
WFS = WIL-FLEX™ [Santoprene®
(Three Black Dots)]

VALVE BALLS
TF = PTFE (White)

VALVE SEATS
K = PVDF
P = POLYPROPYLENE

MANIFOLD O-RINGS
TV = PTFE ENCAP. FKM

SPECIALTY CODES

0014 BPST	0680 P100 0672 Center ported, both ports vertical, NPT OEM specific inlet manifold
0502 PFA coated hardware	0673 Center ported, both ports vertical, BPST
0670 Center ported, vertical inlet only, NPT	0677 Center ported, both ports horizontal, NPT
0671 Center ported, vertical inlet only, BPST	0678 Center ported, both ports horizontal, BPST

NOTE: Most elastomeric materials use colored dots for identification.

NOTE: Not all models are available with all material options.

Section 3

HOW IT WORKS — PUMP

The Wilden diaphragm pump is an air-operated, placement, self-priming pump. These drawings show the flow pattern through the pump upon its initial stroke. It is assumed the pump has no fluid in it prior to its initial stroke.

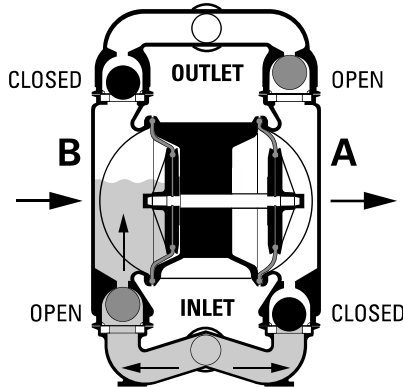

FIGURE 1 The air valve directs pressurized air to the back side of diaphragm A. The compressed air is applied directly to the liquid column separated by elastomeric diaphragms. The diaphragm acts as a separation membrane between the compressed air and liquid, balancing the load and removing mechanical stress from the diaphragm. The compressed air moves the diaphragm away from the center block of the pump. The opposite diaphragm is pulled in by the shaft connected to the pressurized diaphragm. Diaphragm B is on its suction stroke; air behind the diaphragm has been forced out to the atmosphere through the exhaust port of the pump. The movement of diaphragm B toward the center block of the pump creates a vacuum within chamber B. Atmospheric pressure forces fluid into the inlet manifold forcing the inlet valve ball off its seat. Liquid is free to move past the inlet valve ball and fill the liquid chamber (see shaded area).

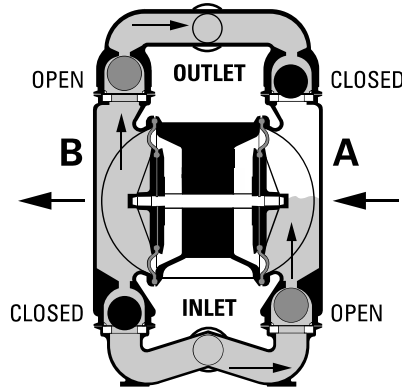

FIGURE 2 When the pressurized diaphragm, diaphragm A, reaches the limit of its discharge stroke, the air valve redirects pressurized air to the back side of diaphragm B. The pressurized air forces diaphragm B away from the center block while pulling diaphragm A to the center block. Diaphragm B is now on its discharge stroke. Diaphragm B forces the inlet valve ball onto its seat due to the hydraulic forces developed in the liquid chamber and manifold of the pump. These same hydraulic forces lift the discharge valve ball off its seat, while the opposite discharge valve ball is forced onto its seat, forcing fluid to flow through the pump discharge. The movement of diaphragm A toward the center block of the pump creates a vacuum within liquid chamber A. Atmospheric pressure forces fluid into the inlet manifold of the pump. The inlet valve ball is forced off its seat allowing the fluid being pumped to fill the liquid chamber.

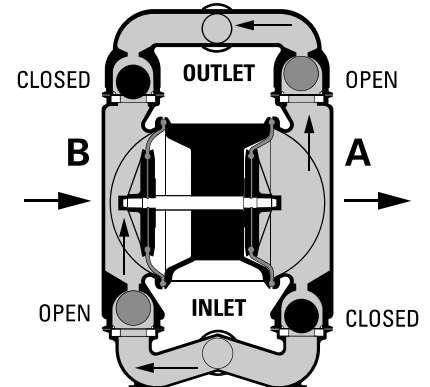
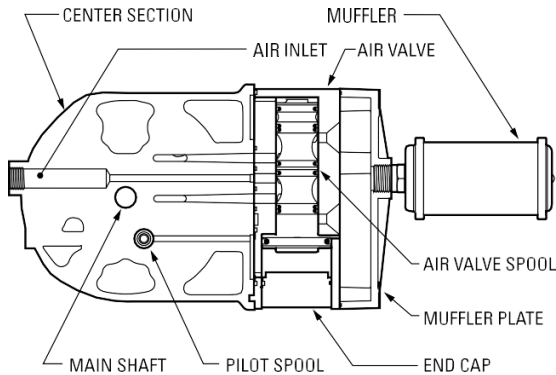

FIGURE 3 At completion of the stroke, the air valve again redirects air to the back side of diaphragm A, which starts diaphragm B on its exhaust stroke. As the pump reaches its original starting point, each diaphragm has gone through one exhaust and one discharge stroke. This constitutes one complete pumping cycle. The pump may take several cycles to completely prime depending on the conditions of the application.

HOW IT WORKS — AIR DISTRIBUTION SYSTEM



The Pro-Flo® patented air distribution system incorporates two moving parts: the air valve spool and the pilot spool. The heart of the system is the air valve spool and air valve. This valve design incorporates an unbalanced spool. The smaller end of the spool is pressurized continuously, while the large end is alternately pressurized then exhausted to move the spool. The spool directs pressurized air to one air chamber while exhausting the other. The air causes the main shaft/diaphragm assembly to shift to one side — discharging liquid on that side and pulling liquid in on the other side. When the shaft reaches the end of its stroke, the inner piston actuates the pilot spool, which pressurizes and exhausts the large end of the air valve spool. The repositioning of the air valve spool routes the air to the other air chamber.

DIMENSIONAL DRAWING

P25 Advanced™ Plastic

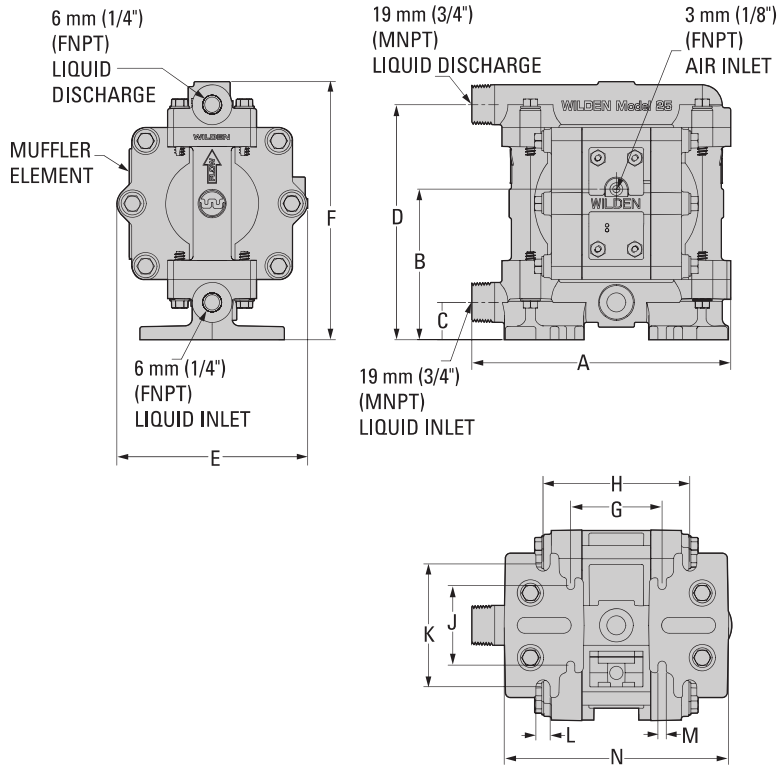

DIMENSIONS

ITEM	METRIC (mm)	STANDARD (inch)
A	173	6.8
B	102	4.0
C	25	1.0
D	157	6.2
E	127	5.0
F	173	6.8
G	61	2.4
H	99	3.9
J	53	2.1
K	81	3.2
L	10	0.4
M	5	0.2
N	150	5.9

Section 5

PERFORMANCE

P25 ADVANCED™ PLASTIC PTFE-FITTED

Height	173 mm (6.8")
Width.....	173 mm (6.8")
Depth	127 mm (5.0")
Ship Weight	Polypropylene 2 kg (4 lbs)
	PVDF 2 kg (5 lbs)
Air Inlet.....	3 mm (1/8")
Inlet.....	6 mm (1/4")
Outlet	6 mm (1/4")
Suction Lift	1.9 m Dry (6.2')
	9.3 m Wet (30.6')
Disp. Per Stroke ¹	0.04 l (0.01 gal.)
Max. Flow Rate.....	16.7 lpm (4.4 gpm)
Max. Size Solids.....	0.7 mm (1/32")

¹Displacement per stroke was calculated at 4.8 bar (70 psig) air inlet pressure against a 2 bar (30 psig) head pressure.

Example: To pump 2.3 lpm (0.6 gpm) against a discharge pressure of 6.2 bar (90 psig) requires 6.9 bar (100 psig) and 3.4 Nm³/h (2 scfm) air consumption. (See dot on chart.)

Caution: Do not exceed 8.6 bar (125 psig) air supply pressure.

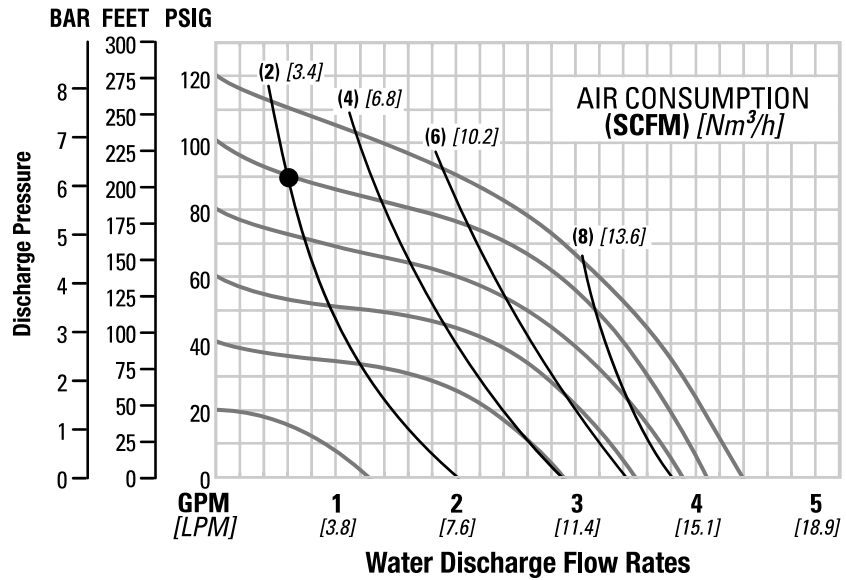

Flow rates indicated on chart were determined by pumping water.

For optimum life and performance, pumps should be specified so that daily operation parameters will fall in the center of the pump performance curve.

SUCTION LIFT CURVES

P25 PLASTIC SUCTION - LIFT CAPABILITY

Suction lift curves are calibrated for pumps operating at 305 m (1000') above sea level. This chart is meant to be a guide only. There are many variables which can affect your pump's operating characteristics. The number of intake and discharge elbows, viscosity of pumping fluid, elevation (atmospheric pressure) and pipe friction loss all affect the amount of suction lift your pump will attain.

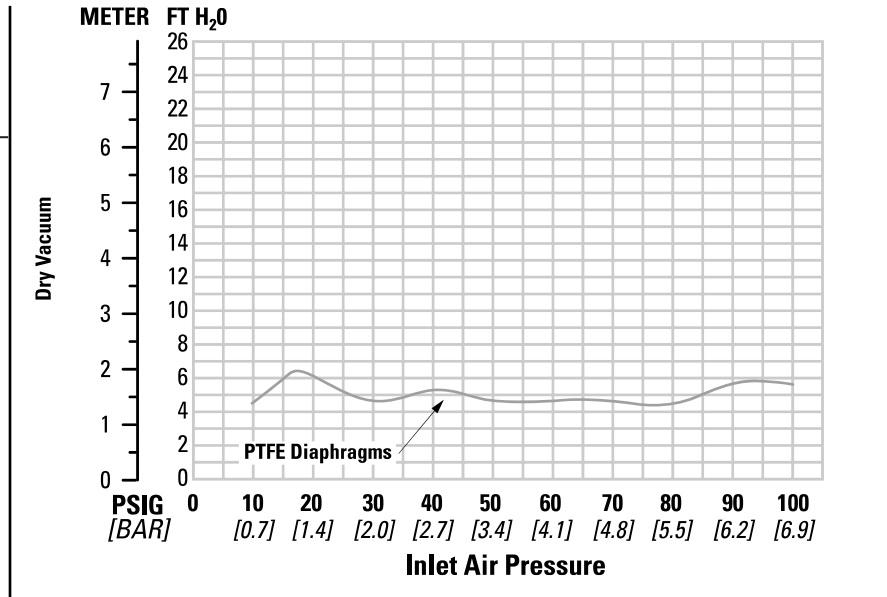

Section 6

Suggested Installation, Operation, Maintenance and Troubleshooting

 **CAUTION:** All fittings and connections must be airtight. Otherwise, pump suction capability will be reduced or lost.

Months of careful planning, study and selection efforts can result in unsatisfactory pump performance if installation details are left to chance. You can avoid premature failure and long-term dissatisfaction by exercising reasonable care throughout the installation process.

Location

Noise, safety and other logistical factors usually dictate where equipment will be situated on the production floor. Multiple installations with conflicting requirements can result in congestion of utility areas, leaving few choices for additional pumps.

Within the framework of these and other existing conditions, every pump should be located in such a way that several key factors are balanced against each other to maximum advantage.:

- **Access:** First of all, the location should be accessible. If it's easy to reach the pump, maintenance personnel will have an easier time carrying out routine inspections and adjustments. Should major repairs become necessary, ease of access can play a key role in speeding the repair process and reducing total downtime.
- **Air Supply:** Every pump location should have an air line large enough to supply the volume of air necessary to achieve the desired pumping rate. Use air pressure up to a maximum of 8.6 bar (125 psig) depending on pumping requirements.
For best results, the pumps should use a 5µ (micron) air filter, needle valve and regulator. The use of an air filter before the pump will ensure that the majority of any pipeline contaminants will be eliminated.
- **Solenoid Operation:** When operation is controlled by a solenoid valve in the air line, three-way valves should be used. This valve allows trapped air between the valve and the pump to bleed off which improves pump performance. Pumping volume can be estimated by counting the number of strokes per minute and then multiplying the figure by the displacement per stroke.
- **Muffler:** Sound levels are reduced below OSHA specifications using the standard Wilden muffler. Other mufflers can be used to further reduce sound levels, but they usually reduce pump performance.

- **Elevation:** Selecting a site that is well within the pump's dynamic-lift capability will assure that loss-of-prime issues will be eliminated. In addition, pump efficiency can be adversely affected if proper attention is not given to site location.

- **Piping:** Final determination of the pump site should not be made until the piping challenges of each possible location have been evaluated. The impact of current and future installations should be considered ahead of time to make sure that inadvertent restrictions are not created for any remaining sites.

The best choice possible will be a site involving the shortest and straightest hook-up of suction and discharge piping. Unnecessary elbows, bends and fittings should be avoided. Pipe sizes should be selected to keep friction losses within practical limits. All piping should be supported independently of the pump. In addition, the piping should be aligned to avoid placing stress on the pump fittings.

Flexible hose can be installed to aid in absorbing the forces created by the natural reciprocating action of the pump. If the pump is to be bolted down to a solid location, a mounting pad placed between the pump and the foundation will assist in minimizing pump vibration. Flexible connections between the pump and rigid piping will also assist in minimizing pump vibration. If quick-closing valves are installed at any point in the discharge system, or if pulsation within a system becomes a problem, a surge suppressor (SD Equalizer®) should be installed to protect the pump, piping and gauges from surges and water hammer.

 **NOTE:** Materials of construction and elastomer material have an effect on suction-lift parameters. Please refer to the performance section for specifics.

When pumps are installed in applications involving flooded suction or suction-head pressures, a gate valve should be installed in the suction line to permit closing of the line for pump service.

Pumps in service with a positive suction head are most efficient when inlet pressure is limited to 0.5–0.7 bar (7–10 psig). Premature diaphragm failure may occur if positive suction is 0.7 bar (10 psig) and higher.

 **CAUTION:** Do not exceed 8.6 bar (125 psig) air supply pressure.

Suggested Installation, Operation, Maintenance and Troubleshooting

This illustration is a generic representation of an air-operated double-diaphragm pump.

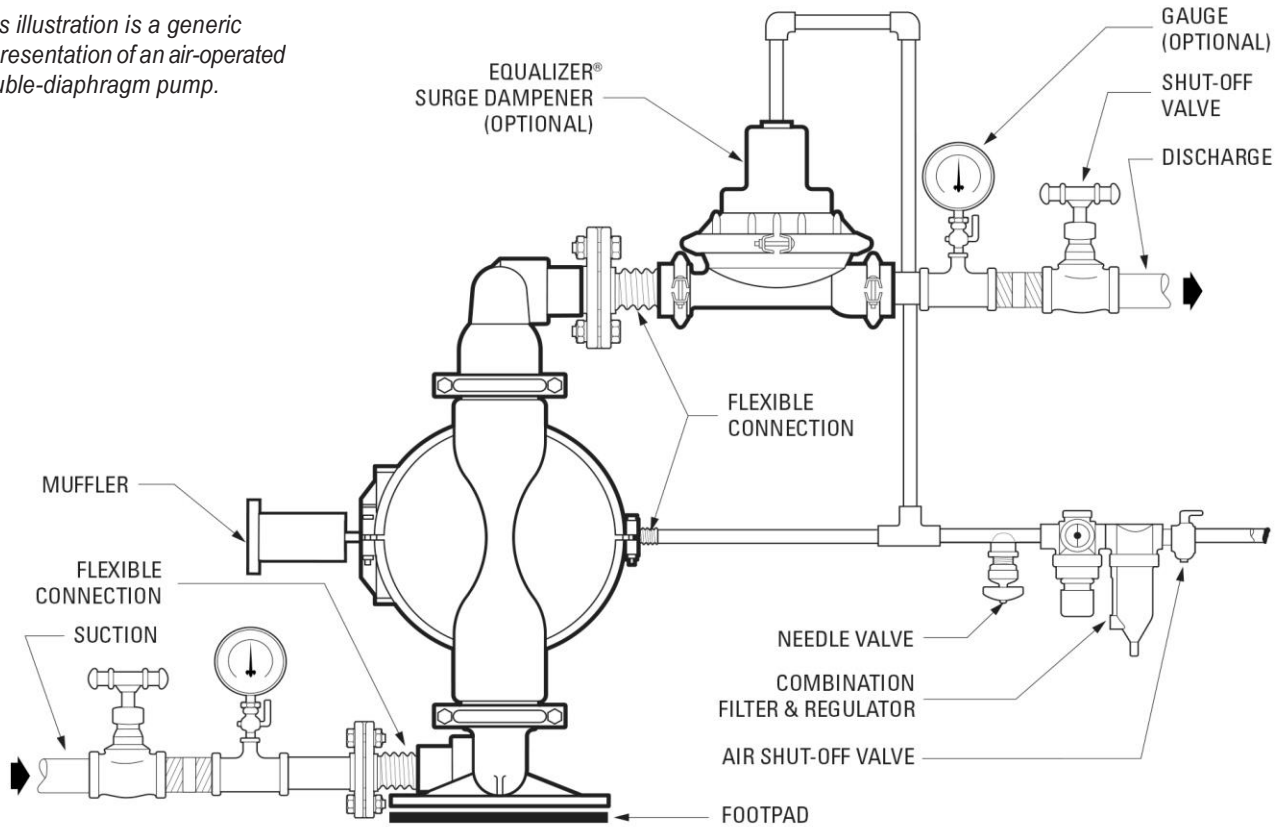

NOTE: In the event of a power failure, the shut-off valve should be closed, if the restarting of the pump is not desirable once power is regained.

Air-Operated Pumps: To stop the pump from operating in an emergency situation, simply close the shut-off valve (user-supplied) installed in the air supply line. A properly functioning valve will stop the air supply to the pump, therefore stopping output. This shut-off valve should be located far enough away from the pumping equipment such that it can be reached safely in an emergency situation

Operation

The P25 Advanced™ plastic is permanently lubricated and does not require in-line lubrication. Additional lubrication will not damage the pump, however if the pump is heavily lubricated by an external source, the pump's internal lubrication may be washed away. If the pump is then moved to a non-lubricated location, it may need to be disassembled and re-lubricated as described in the ASSEMBLY/DISASSEMBLY INSTRUCTIONS.

Pump discharge rate can be controlled by limiting the volume and/or pressure of the air supply to the pump. An air regulator is used to regulate air pressure. A needle valve is used to regulate volume. Pump discharge rate can also be controlled by throttling the pump

discharge by partially closing a valve in the discharge line of the pump. This action increases friction loss which reduces flow rate. (See Section 5.) This is useful when the need exists to control the pump from a remote location. When the pump discharge pressure equals or exceeds the air supply pressure, the pump will stop; no bypass or pressure relief valve is needed, and pump damage will not occur. The pump has reached a "deadhead" situation and can be restarted by reducing the fluid discharge pressure or increasing the air inlet pressure. Wilden Pro-Flo® SHIFT pumps run solely on compressed air and do not generate heat; therefore, your process fluid temperature will not be affected.

Maintenance and Inspections

Since each application is unique, maintenance schedules may be different for every pump. Frequency of use, line pressure, viscosity and abrasiveness of process fluid all affect the parts life of a Wilden pump. Periodic inspections have been found to offer the best means for preventing unscheduled pump downtime. Personnel familiar with the pump's construction and service should be informed of any abnormalities that are detected during operation.

Suggested Installation, Operation, Maintenance and Troubleshooting

Troubleshooting

Pump will not run or runs slowly.

1. Ensure that the air inlet pressure is at least 0.3 bar (5psig) above start up pressure and that the differential pressure (the difference between air inlet and liquid discharge pressures) is not less than 0.7 bar (10psig).
2. Check air inlet filter for debris (see SUGGESTED INSTALLATION).
3. Check for extreme air leakage (blow by) that would indicate worn seals/bores in the air valve, pilot spool and main shaft.
4. Disassemble pump and check for obstructions in the air passageways or objects that would obstruct the movement of internal parts.
5. Check for sticking ball check valves. If material being pumped is not compatible with pump elastomers, swelling may occur. Replace ball check valves and seals with proper elastomers. Also, as the check valve balls wear out, they become smaller and can become stuck in the seats. In this case, replace balls and seats.
6. Check for broken inner piston that will cause the air valve spool to be unable to shift.
7. Remove plug from pilot spool exhaust.

Pump runs but little or no product flows.

1. Check for pump cavitation; slow pump speed down to allow thick material to flow into liquid chambers.
2. Verify that vacuum required to lift liquid is not greater than the vapor pressure of the material being pumped (cavitation).

3. Verify that vacuum required to lift liquid is not greater than the vapor pressure of the material being pumped (cavitation).
4. Check for sticking ball check valves. If material being pumped is not compatible with pump elastomers, swelling may occur. Replace ball check valves and seats with proper elastomers. Also, as the check valve balls wear out, they become smaller and can become stuck in the seats. In this case, replace balls and seats.

Pump air valve freezes.

1. Check for excessive moisture in compressed air. Either install a dryer or hot-air generator for compressed air. Alternatively, a coalescing filter may be used to remove the water from the compressed air in some applications.

Air bubbles in pump discharge.

1. Check for ruptured diaphragm.
2. Check tightness of outer pistons (refer to Section 7).
3. Check tightness of fasteners and integrity of O-rings and seals, especially at intake manifold.
4. Ensure pipe connections are airtight.

Product comes out air exhaust.

1. Check for diaphragm rupture.
2. Check tightness of outer pistons to shaft.

Section 7

Disassembly / Reassembly

Pump Disassembly

Tools Required:

- 7/16" Wrench or Socket for Rubber-Fitted
- 3/8" Wrench

⚠ CAUTION: Before any maintenance or repair is attempted, the compressed air line to the pump should be disconnected and all air pressure allowed to bleed from pump. Disconnect all intake, discharge, and air lines. Drain the pump by turning it upside down and allowing any fluid to flow into a suitable container. Wetted flushing of parts may be required prior to handling.

To expedite parts ordering, please find an exploded view of the P25 model at the back of this manual.

PLEASE read all directions before starting disassembly.

⚠ NOTE: Replace worn parts with genuine Wilden parts for reliable performance.



Step 1

Before actual disassembly is started, turn pump upside down and drain all liquid trapped in the pump into a suitable container. Be sure to use proper caution if liquid is corrosive or toxic. Please note alignment marks on center section. Use to properly align liquid chamber to center section.



Step 2

Using a 3/8" wrench, loosen the discharge manifold from the liquid chambers.



Step 3

Remove the discharge manifold to expose the valve balls and manifold o-rings.

Disassembly / Reassembly

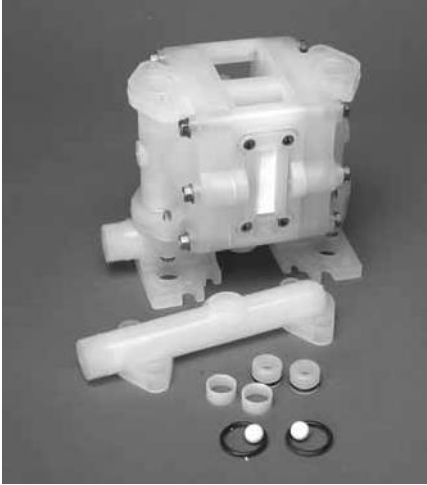

Step 4

Remove the discharge valve balls, manifold o-rings and discharge manifold. Inspect for nicks, gouges, chemical attack or abrasive wear.



NOTE: replace worn parts with genuine Wilden parts for reliable performance.



Step 5

Using a 3/8" wrench, remove the inlet manifold.

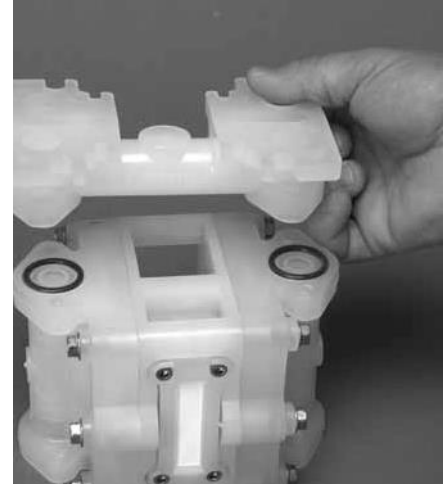

Step 6

Remove the inlet valve balls, manifold o-rings and inlet manifold. Inspect for nicks, gouges, chemical attack or abrasive wear.



Step 7

Using a 3/8" wrench, remove the liquid chambers from the center section.

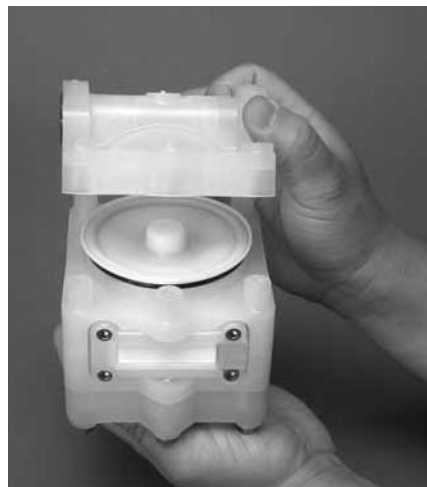

Step 8

Remove liquid chambers to expose the diaphragm and outer piston.



Step 9

To remove PTFE-fitted diaphragms, turn the entire diaphragm in a counterclockwise direction.



NOTE: PTFE fitted pumps use a PTFE diaphragm with an integral outer piston and neoprene back up o-ring.

Disassembly / Reassembly

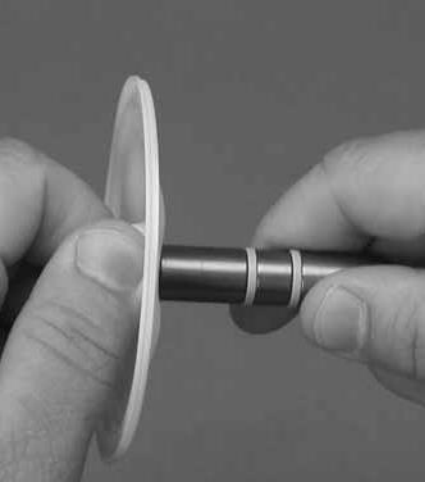

Step 10

Remove the opposite side diaphragm and shaft from the center section. With shaft secured, remove diaphragm by turning counterclockwise.

Disassembly / Reassembly

Air Valve / Center Section Disassembly

Tools Required:

- 5/32" Hex Head Wrench
- O-ring Pick



CAUTION: Before any maintenance or repair is attempted, the compressed air line to the pump should be disconnected and all air pressure allowed to bleed from the pump. Disconnect all intake, discharge, and air lines. Drain the pump by turning it upside down and allowing any fluid to flow into a suitable container. Be aware of hazardous effects of contact with your process fluid.

The Wilden P25 Advanced™ plastic utilizes a revolutionary Pro-Flo® air distribution system. Proprietary composite seals reduce the coefficient of friction and allow the P25 to run lube-free. Constructed of polypropylene, the Pro-Flo® air distribution system is designed to perform in on/off, non-freezing, non-stalling, tough duty applications.



NOTE: Replace worn parts with genuine Wilden parts for reliable performance.

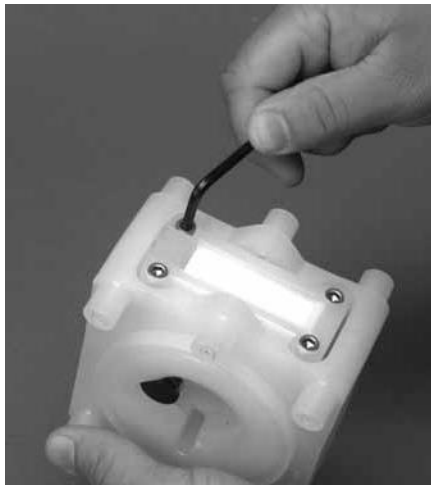

Step 1

Remove air valve screws from center section with a 5/32" hex head wrench.



Step 2

Take care while removing air valve not to damage gasket.



NOTE: Air valve has molded in alignment pins for proper positioning during assembly.

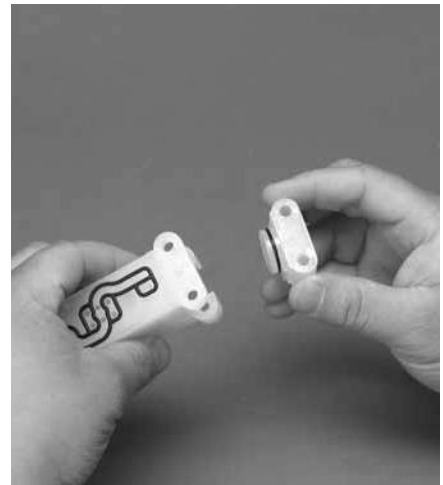

Step 3

Remove air valve end cap by simply pulling it away from air valve body (no tools required). Inspect o-ring and replace as needed with genuine Wilden parts.

Disassembly / Reassembly



Step 4

The air valve spool can now be removed. A 10-24 UNC (Unified National Coarse thread) screw can be screwed into the threaded hole located in the center of the spool. Grip the screw with pliers and remove. If a 10-24 UNC screw is not available, the spool can be tapped out against a wood block or blown out with compressed air. Upon reassembly, lubricate air valve with NLGI grade 2 white EP bearing grease.

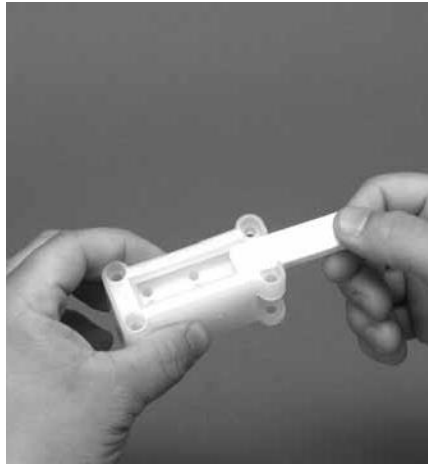

Step 5

Remove the porous polyethylene muffler element by sliding it toward the end cap opening. The element can be cleaned by soaking it in a cleaning solution (no solvents). If the muffler restricts the air exhaust, replace muffler element.



Step 6

Remove pilot spool retaining ring with an o-ring pick.



Step 7

Push pilot spool through center section and remove. Inspect seals for integrity and spool for damage. Replace pilot spool assembly if necessary. Upon reassembly of spool, apply a small amount of NLGI grade 2 white EP bearing grease or equivalent (P/N 99-8310-99).

Disassembly / Reassembly

Reassembly Hints & Tips

Upon performing applicable maintenance to the air distribution system, the pump can now be reassembled. Please refer to the disassembly instructions for photos and parts placement. To reassemble pump, follow the disassembly instructions in reverse order. The air distribution system needs to be assembled first, then the diaphragms, and finally the wetted parts. Please find applicable torque specifications in this section.

The following tips will assist in the assembly process.

- Clean the inside of the center section shaft bore to ensure no damage is done to new seals.
- Stainless bolts should be lubed to reduce the possibility of seizing during tightening.
- Be sure to tighten outer pistons simultaneously on PTFE- fitted pumps to ensure proper torque values.
- Apply a small amount of Loctite 242 to the shaft interval threads before the diaphragm assembly.
- Concave side of disc spring in diaphragm assembly faces **toward** inner piston.

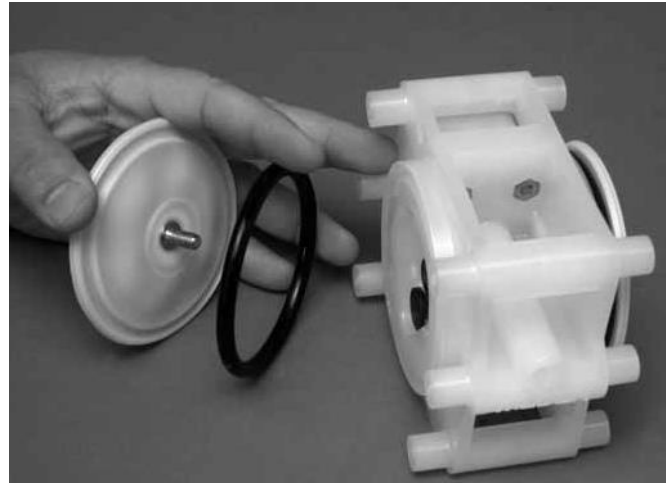

PTFE diaphragm configuration

Lubricate the main shaft assembly with NLGI grade 2 white EP bearing grease or equivalent and insert through main shaft bore in center section. Assemble the other side and torque to proper value as listed below. Please review the photos above for proper alignment.

PRO-FLO® MAXIMUM TORQUE SPECIFICATIONS

Description of Part	Torque
Air Valve	[2.3 N•m] 20 in.-lbs
Liquid Chamber Bolt	[6.2 N•m] 55 in.-lbs.
Manifold Bolt	[6.2 N•m] 55 in.-lbs.

Section 8

Exploded View and Parts Listing

P25 ADVANCED™ PLASTIC

PTFE FITTED

EXPLODED VIEW

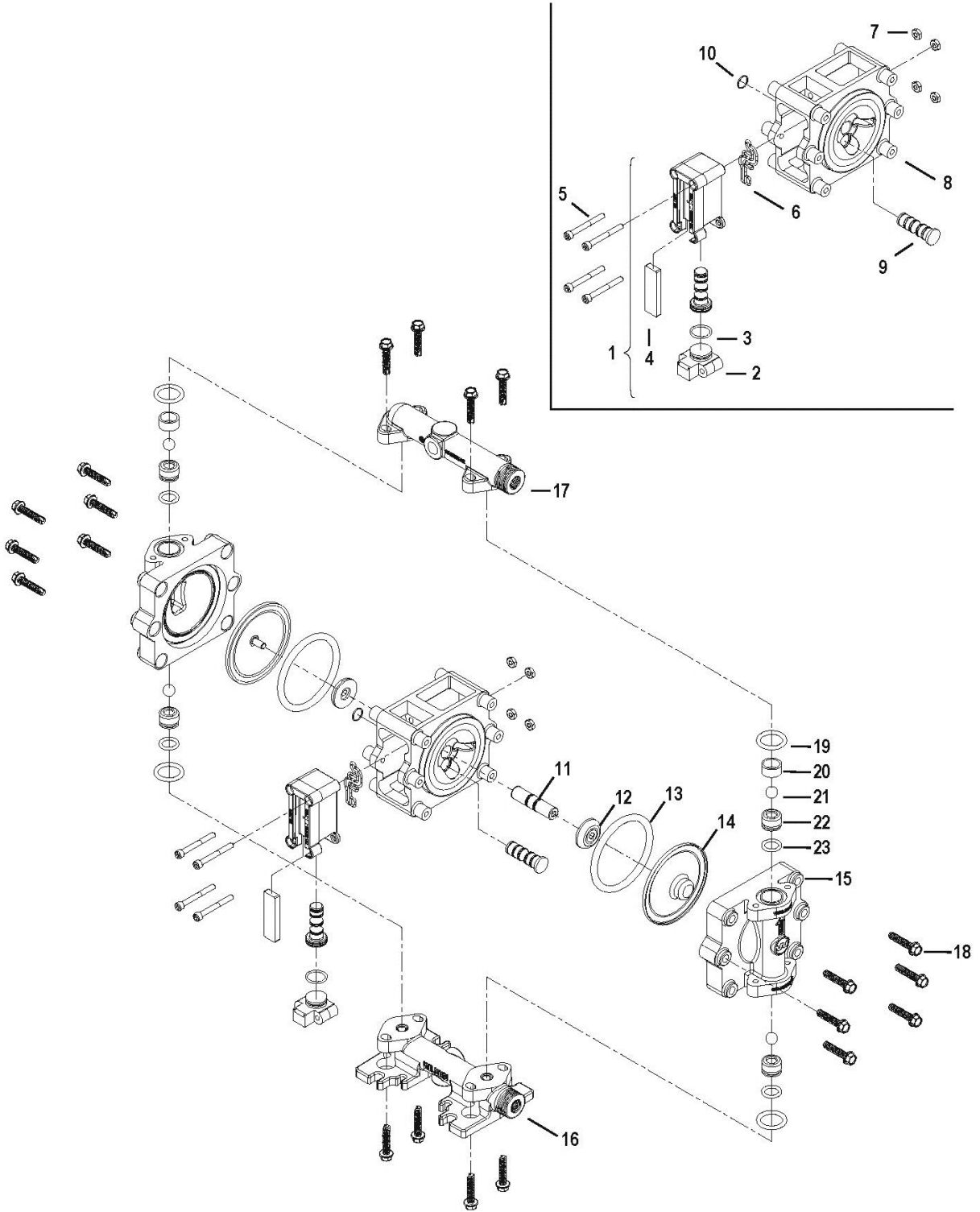

Exploded View and Parts List

Item #	Description	Qty. per Pump	P25/PZPPP P/N	P25/PZPPP/502 P/N	P25/KZPPP P/N	P25/KZPPP/502 P/N
1	Pro-Flo[®] Air Valve Assembly¹	1	00-2000-20-700	00-2000-13-700	00-2000-20-700	00-2000-13-700
2	Pro-Flo [®] Air Valve End Cap	1	00-2300-20-700	00-2300-13-700	00-2300-20-700	00-2300-13-700
3	End Cap O-Ring	1	00-2390-52-700	00-2390-52-700	00-2390-52-700	00-2390-52-700
4	Muffler Element	1	00-3240-26-700	00-3240-26-700	00-3240-26-700	00-3240-26-700
5	Air Valve Bolt	4	00-6000-03-700	00-6000-05-700	00-6000-03-700	00-6000-05-700
6	Air Valve Gasket	1	00-2600-52-700	00-2600-52-700	00-2600-52-700	00-2600-52-700
7	Air Valve Nut	4	01-6400-03	01-6400-05	01-6400-03	01-6400-05
8	Pro-Flo [®] Center Section	1	00-3155-20	00-3155-20	00-3155-20	00-3155-20
9	Pilot Spool Assembly	1	00-3850-99-700	00-3850-99-700	00-3850-99-700	00-3850-99-700
10	Pilot Spool Retaining Ring	1	00-2650-03-700	00-2650-03-700	00-2650-03-700	00-2650-03-700
11	Main Shaft Assembly	1	00-3800-99-700	00-3800-99-700	00-3800-99-700	00-3800-99-700
12	Inner Piston for PTFE	2	00-3750-20-700	00-3750-20-700	00-3750-20-700	00-3750-20-700
13	Backup O-ring	2	00-1070-51	00-1070-51	00-1070-51	00-1070-51
14	Diaphragm	2	00-1030-55	00-1030-55	00-1030-55	00-1030-55
15	Liquid Chamber	2	00-5005-20	00-5005-20	00-5005-21	00-5005-21
16	Inlet Manifold	1	00-5095-20	00-5095-20	00-5095-21	00-5095-21
17	Discharge Manifold	1	00-5035-20	00-5035-20	00-5035-21	00-5035-21
18	Screw, HWHTap (BT), 1/4-20 x 1-1/4"	20	00-6350-03	00-6350-05	00-6350-03	00-6350-05
19	Manifold O-Ring	4	*	*	*	*
20	Retainer Sleeve	2	00-5440-20	00-5440-20	00-5440-21	00-5440-21
21	Valve Ball	4	00-1080-55	00-1080-55	00-1080-55	00-1080-55
22	Valve Seat	4	00-1130-20	00-1130-20	00-1130-21	00-1130-21
23	Valve Seat O-Ring	4	*	*	*	*

* Refer to Elastomer Options in Section 9.

¹Air Valve Assembly includes items 2, 3 and 4.

All boldface items are primary wear parts.

Section 9

Elastomer Options

P25 Advanced™ Plastic

Material	Diaphragm	Back-Up O-Ring	Valve Seat O-Ring	Manifold O-Ring
Neoprene		00-1070-51		
PTFE	00-1030-55			
FKM		00-1070-53		
EPDM		00-1070-54		
PTFE Encapsulated FKM			00-1206-60	01-1200-60-520

Notes

Notes

PSG
22069 Van Buren Street
Grand Terrace, CA 92313-5651 USA
P: +1 (909) 422-1730 • F: +1 (909) 783-3440
psgdover.com



Where Innovation Flows

PSG[®] reserves the right to modify the information and illustrations contained in this document without prior notice. This is a non-contractual document. 05-2018