

WILDEN®

Clean
Performance that
Meets the
Highest
Standards

SANIFLO™
BRAND PORTFOLIO

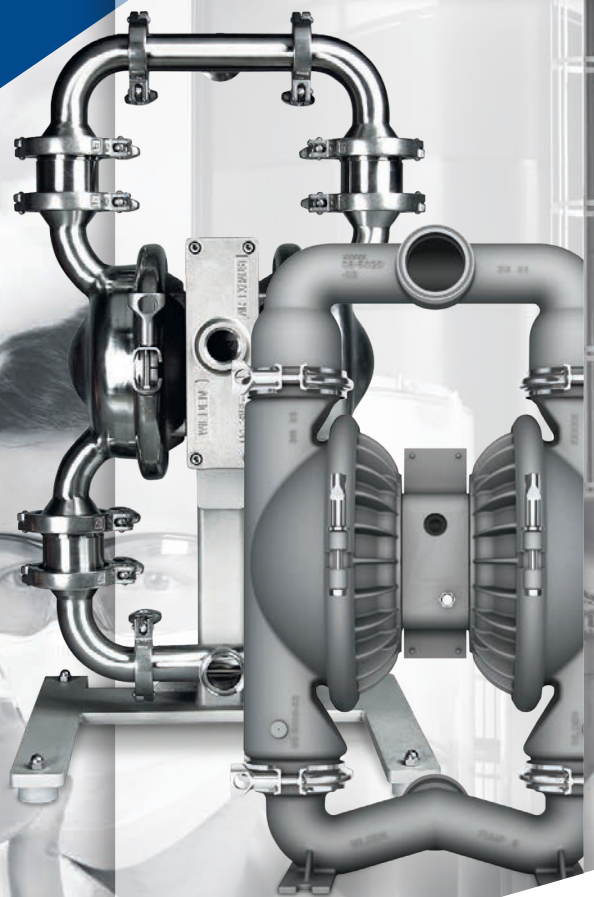

Where Innovation Flows

wildenpump.com

AIR-OPERATED DOUBLE-DIAPHRAGM PUMPS

PSG
a  DOVER company



Saniflo™ Solutions

Wilden is a global leader in hygienic and bio-pharmaceutical pumps and offers a wide range of solutions for various food, beverage, dairy, personal care and biopharmaceutical applications. Wilden's Saniflo™ FDA and Hygienic™ Series pumps have been engineered to meet the highest standards and requirements in the industry including: EHEDG, 3A, CE, ATEX, USP Class VI, 1935/2004/EC and FDA CFR 21.177.

Wilden's premiere Saniflo™ and Hygienic™ pumps have the versatility you require, the safety you need, and the capability of efficiently pumping a wide range of viscosities, solids, and shear sensitive products. These pumps are offered with passivated stainless steel components, available in multiple sizes, and with various surface finishes. As the global leader in AODD pumps, we are committed to your industry. Wilden understands that safety, performance, hygienic requirements and the gentle transfer of your products are essential when choosing process equipment.

WILDEN, The Evolution of Clean

Unique Characteristics

- Air-operated pumps (non electrical)
- Superior product containment
- Clamped for quick knock down
- Self priming/dry priming
- No damage when run dry
- Deadhead without damage
- Variable flow and pressure
- High viscosity holding
- Intrinsically safe by design
- Lube-free operation
- Shear sensitive product handling
- Large solids passage
- Low water requirement
- Low product degradation
- Ease of operation and maintenance

Difficult Applications

- Sauces, purees and beverages
- Poultry, fish and meat process
- Fruits, vegetables and condiments
- Ingredient receiving/unloading
- Batch/load cell metering
- Pharmaceutical product
- Chromatography, separation and purification
- Health and personal care products
- High purity product transfer
- Filter press feed pumps
- Acids, solvents, caustics and alcohols
- Abrasive media and solids
- Chemical injections and metering
- Waste water transfer
- CIP, SIP, COP



Prepared Foods



Sauces



Confectionary



Fruits & Vegetables



Beverages



Dairy

SANIFLO™ FDA & HYGEINIC™ Series Solutions



Meat



Poultry



Fish



Bio-Pharmaceutical



Pharmaceutical



Cosmetics





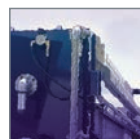





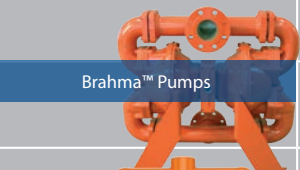
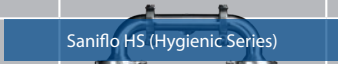

Process Support



Waste



Pump Selection Guide for Sanitary and Hygienic Applications

SOLIDS HANDLING ABILITY				
	152 mm + (6"+)			
76 mm (3")	 Brahma™ Pumps		 Saniflo HS (Hygienic Series)	
51 mm (2")				
25 mm (1")	 Advanced™ FIT Pumps			
18 mm (3/4")				
12 mm (1/2")	 Stallion® Pumps & Advanced™ Plastic Pumps	 Saniflo FDA Pumps		 Saniflo HS (Pharma) *RR Only
6 mm (1/4")				
SANITARY APPLICATION RANGE (cleaning method)	Non sanitary, waste, crude and CIP chemicals (includes disposable technology)	High acid, high sugar, high fat food (COP)	Low acid, pasteurized and protein based products (COP/CIP/SIP)	Bio-Pharmaceutical sterile processes (COP, CIP/SIP)
PRODUCT EXAMPLES	Process Waste, CIP Chemicals, Utilities	Sweeteners, icings, juices, fruit ingredients, some sauces	Milk, meat, egg, vegetable based products, personal care products	Active pharmaceutical ingredients, cosmetic, live cultures
CERTIFICATIONS		 	 	
POLISH LEVELS μ-m (μ-inch) Ra		Ra 5.1 μm (200 μ-in)	Ra 0.8 μm (32 μ-in)	Ra 0.4 μm (6 μ-in)

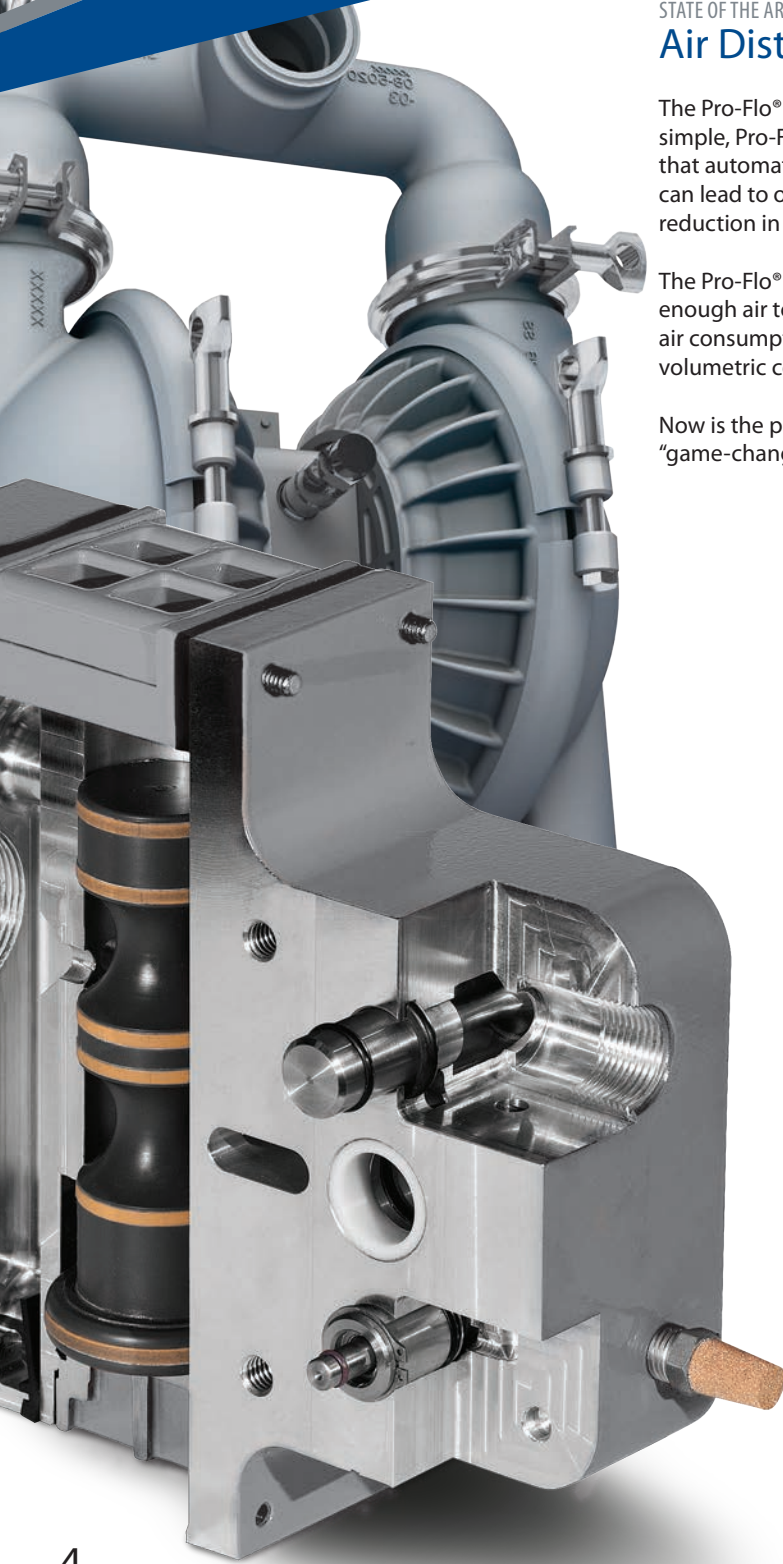

STATE OF THE ART

Air Distribution Systems

The Pro-Flo® SHIFT is the new standard for AODD pumps. The innovative, yet simple, Pro-Flo® SHIFT Air Distribution System (ADS) features an “air control spool” that automatically optimizes air consumption and eliminates the overfilling that can lead to overcharging of the air chamber, all while causing no corresponding reduction in flow rate.

The Pro-Flo® SHIFT’s revolutionary ADS design meters the air flow, allowing for just enough air to keep the pumping process operational. The results are a reduction in air consumption and operational costs while maximum operational efficiency and volumetric consistency are maintained.

Now is the perfect time to shift your thinking in AODD pump performance with the “game-changing” Pro-Flo® SHIFT.



Market Position:

- Cost efficient: 50% less expensive than an electronically-actuated ADS
- Faster return on investment
- Robust design for harsh operating conditions
- Metered air consumption for less product waste
- Creates the highest performance ratio
- Superior flow rate
- Superior anti-freezing
- Single-point exhaust option
- Lube-free operation
- Reduced maintenance costs
- ON/OFF reliability
- Environmental sensitivity

Features:

- Simple and durable pump design
- Simple components
- Faster, easier setup time
- Plug-N-Play operation
- No electricity needed
- Precise flow rate at start-up
- Non-stalling unbalanced spool

- Reduced energy consumption
- Lower carbon footprint
- ATEX-compatible for use in explosive atmospheres

Application Traits:

- Greater yield per SCFM of air used
- Wider application range
- Repeatable, predictable performance
- Less product waste
- Max. Mean Time Between Repair (MTBR)
- Increased application range/compatibility
- Minimum training required
- No special skill set needed for maintenance or operation

Availability:

- 38 mm (1-1/2")
- 51 mm (2")
- 76 mm (3")

SHIFTING PERFORMANCE TO A WHOLE NEW LEVEL.

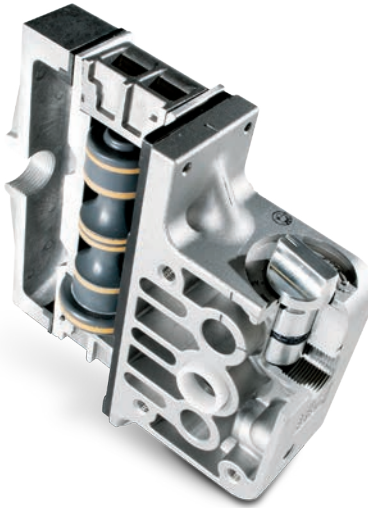

Market Position:

- Variable control (discharge flow rates and air consumption)
- Superior flow rate
- Superior anti-freezing
- Single-point exhaust options
- Lube-free operation
- ON/OFF reliability
- ATEX models available

Features:

- Efficiency Management System (EMS™)
- Metal and plastic material options
- Non-stalling unbalanced spool
- Simple and durable design

Application Traits:

- Maximize performance and efficiency
- Process applications
- Max. Mean Time Between Repair (MTBR)

Availability:

- 13 mm (1/2")
- 25 mm (1")
- 38 mm (1-1/2")
- 51 mm (2")
- 76 mm (3")
- 102 mm (4")

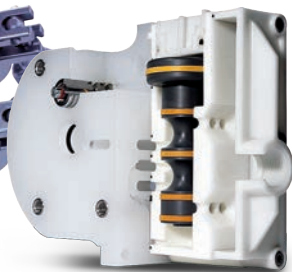

Market Position:

- Anti-freezing
- ON/OFF reliability
- Longest-lasting wear parts
- Lube-free operation

Features:

- Plastic center block
- Non-stalling unbalanced spool
- Simple and durable design

Application Traits:

- Maximum reliability
- Process applications
- Max. Mean Time Between Repair (MTBR)

Availability:

- 13 mm (1/2"), 25 mm (1"), 38 mm (1-1/2"), 51 mm (2")

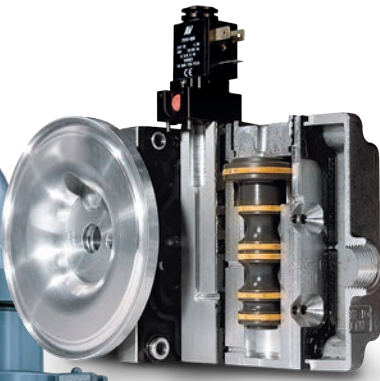

Market Position:

- Direct electrical interface
- Superior ON/OFF reliability
- Reduced systems costs
- Lube-free operation

Features:

- Externally controlled
- Various voltage options
- Nema 4, Nema 7 or ATEX
- Simple installation

Application Traits:

- System automation
- 4-20 mA pH adjusting
- Batching applications
- OEM accounts

Availability:

- 13 mm (1/2"), 25 mm (1")



Progressive Diaphragm Technology



Thermoplastic Elastomer (TPE)

- Wil-Flex™ is the first choice for Hygienic applications and provides a low-cost alternative to PTFE with a cost comparable to neoprene. Made of Santoprene™, Wil-Flex is ideal for use with acidic and caustic fluids such as sodium hydroxide, sulfuric or hydrochloric acids. Exhibiting excellent flex life, abrasion resistance, temperature range and durability, it is widely used in the chemical process, food, pharmaceutical and wastewater industries. Versions of Wil-Flex are available that comply with FDA 21 CFR 177 standards for food and beverage applications.
- Saniflex™ is an excellent material for food processing applications. Made of Hytrel®, it exhibits good flex life and excellent abrasion resistance. Hytrel also offers superior sealing or seal energizing due to its low compression set characteristics. Saniflex versions are available that comply with FDA 21 CFR 177 standards.

Polytetrafluoroethylene (PTFE) Elastomers

- Because it is one of the most chemically inert compounds available, PTFE can be used with an extremely wide range of fluids. PTFE is excellent for highly aggressive fluids such as aromatic or chlorinated hydrocarbons, acids, caustics, ketones and acetates. Its properties provide excellent flex life and moderate abrasion resistance. In addition, PTFE complies with FDA 21 CFR 177 and USP Class VI standards for food, beverage and pharmaceutical applications. Because PTFE is non-elastic, a backup diaphragm of a different material must be used to provide flexibility and memory. Material options for backup diaphragms are Neoprene, Saniflex and high temperature Buna-N.

Elastomer Temperature Limits:

Rubber	Buna-N	-12° to 82°C [10° to 180°F]
	EPDM	-51° to 138°C [-60° to 280°F]
Thermoplastic (TPE)	Wil-Flex™	-40° to 107°C [-40° to 225°F]
	Saniflex™	-29° to 104°C [-20° to 220°F]
PTFE	PTFE	4° to 104°C [40° to 220°F]

CAUTION: Maximum temperature limits are based upon mechanical stress only. Certain chemicals will significantly reduce maximum safe operating temperatures. Please verify the chemical resistance limitations of elastomers and all other pump components prior to pump installation. Wilden's online Chemical Guide and a Wilden distributor should be consulted for specifics in elastomer selection.

Go to www.wildenchemicalguide.com for your Wilden Chemical Compatibility Chart.

Hytrel® is a registered trademark of DuPont Company. Santoprene™ is a trademark of ExxonMobil



Rubber Elastomers

- Buna-N provides excellent performance in applications involving petroleum/oil-based fluids such as leaded gasoline, fuel oils, kerosene, turpentine and motor oils. In wide use throughout the fuel processing industry, Buna-N is also referred to as nitrile and provides moderate flex life and moderate abrasion resistance. For food and beverage applications, versions are available that comply with FDA 21 CFR 177 standards.
- EPDM is an excellent material for extremely cold temperatures and is an economical alternative when pumping dilute acids or caustics. EPDM diaphragms are in use in the manufacturing, food, pharmaceutical and paint/coating industries. The material exhibits good flex life and moderate abrasion resistance, and it is available in versions that comply with FDA 21 CFR 177 standards. EPDM is also a good choice where statically dissipative materials are required.



WILDEN
10419
Made in USA

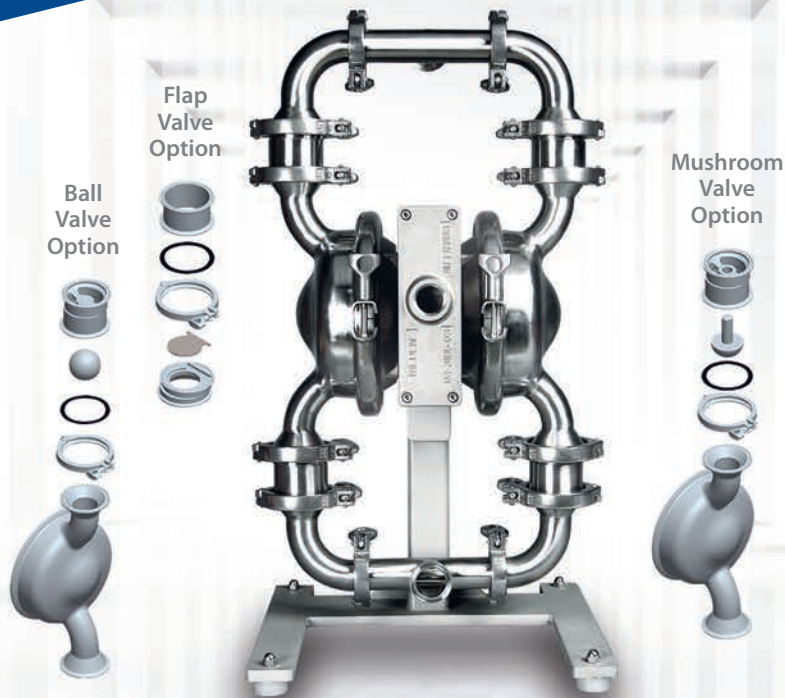

SANIFLO™ HS Hygienic Pumps

Features

- Pro-Flo® SHIFT and Pro-Flo X™ ADS
- Sanitary and hygienic applications
- Delicate/shear sensitive product handling
- Integral piston diaphragm options
- Multiple sanitary elastomers available
- Superior product containment
- Swivel stand available
- CIP (clean-in-place)
- Multiple certification levels available
- Offset valve housing for easy alignment

Tech Data

- Sizes available 25 mm (1") through 76 mm (3")
- 316L stainless steel wetted components
- Contact surfaces with Ra 0.8 µm (32 µ-in) polish
- Valve options available: ball, mushroom, flap
- Available in Tri-clamp™, DIN and SMS style connections

Performance Data

- Max flow rates: 874 lpm (231 gpm) [Ball Valves]
- Max suction lift: 5.5 m (19.2') dry, 9.3 m (30.6') wet [Ball Valves]
- Max size solids: 76 mm (3") [Flap Valves] (not available in 25 mm (1") models)

Certifications





SANIFLO™ FDA Sanitary Pumps

Features

- Pro-Flo® SHIFT, Pro-Flo X™, Pro-Flo® and Accu-Flo™ ADS available
- For sanitary applications
- Multiple sanitary FDA elastomers available
- Delicate/shear sensitive product handling
- Superior product containment
- Intrinsically safe options

Certifications



Tech Data

- Sizes available: 13 mm (1/2") through 76 mm (3")
- Contact surfaces with Ra 5.1 µm (200 µin) polish
- 316 stainless steel wetted components
- Tri-clamp™ style connections

Performance Data

- Max flow rates: 920 lpm (243 gpm)
- Max suction lift: 7.6 m (25.0') Dry, 9.5 m (31.2') Wet
- Max size solids: 9.5 mm (3/8")



HYGIENIC/SANITARY Accessories



Surge Dampener

Features and Benefits

- FDA CFR 21.177
- USP Class VI
- ATEX II 2 GD X
- EHEDG-certified, Document No. 8, when properly configured and installed
- CIP capable
- Large solids capacity
- Liquid chamber designed for superior delicate product handling, drain-ability and diaphragm life
- Surface finish of Ra 0.8 μm (32 $\mu\text{-in}$) or better for optimum clean-ability
- Minimize pressure fluctuation
- Prevent water hammer and associated damage
- Self-adjusting to varying system pressures
- Lower system maintenance cost
- Suction stabilizer
- Extend and improve pump performance
- Minimize spare parts inventory

Wetted Housing

- 316L Stainless Steel (HS only)
- Aluminum
- Ductile Iron
- Polypropylene
- PVDF

Air Distribution System

- 316 Stainless Steel
- Aluminum
- Polypropylene
- Glass-filled Polypropylene
- Mild Steel PTFE-coated

Available Sizes

- 13 mm (1/2")
- 25 mm (1")
- 38 mm (1-1/2")
- 51 mm (2")
- 76 mm (3")

Connection Type

- Tri-Clamp (HS only)
- NPT/BSPT
- ANSI Flange
- DIN (HS only)
- SMS (HS only)



Electronic Accessories

Leak Detection

- Detects diaphragm failure at the source: The PTFE primary diaphragm
- Sensors are located between the primary and back-up (containment) diaphragms
- When the sensors detect a conductive liquid, an audible alarm, LED, and an internal latching relay are activated
- Increase containment, reduce fugitive emissions, and reduce down time with 24-hour pump surveillance
- Power Requirement: 110V AC or 220V AC

Pump Cycle Monitor

- The PCMI counts pump cycles by sensing the presence of the air valve spool
- The Sensor, located at the air valve end cap, detects the presence of a magnet located at the end of the air valve piston/spool
- The PCMI unit registers a complete pump cycle when the piston/spool shifts away from the sensor and subsequently returns to the original position
- The PCMI unit has a reset switch located on the face of the PCMI module
- PCMI also has the ability to be reset from a remote location



Drum Unloading

Drum & Tote Unloading

- Universal kit for 6 mm (1/4") and 13 mm (1/2") pumps
- Fits 51 mm (2") NPT bungholes
- Tube length can be cut to length
- Variety of materials are available



METAL TECHNICAL SPECS

SIZING CONSIDERATIONS

	MODEL	WETTED MATERIALS	LIQUID INLET	LIQUID DISCHARGE	CONNECTION TYPE			SHIPPING WEIGHT	AIR INLET	HEIGHT	WIDTH	DEPTH
					TRI-CLAMP STYLE	DIN 3267 ISO 1145	SMS 1145					
PRO-FLO® SHIFT HYGIENIC	PS4 HS PS4 HS w/swivel	Stainless Steel	38 mm (1-1/2")	38 mm (1-1/2")	•	•	•	51 kg (112 lbs)	19 mm (3/4")	767 mm (30.2") 864 mm (34.0")	440 mm (17.5") 440 mm (17.5")	386 mm (15.2")* (AL ADS) 374 mm (14.7")* (SS ADS) 522 mm (20.5")* (AL ADS) 509 mm (20.0")* (SS ADS)
	PS8 HS PS8 HS w/swivel	Stainless Steel	51 mm (2")	51 mm (2")	•	•	•	49 kg (109 lbs)	19 mm (3/4")	962 mm (37.9") 989 mm (38.9")	460 mm (18.1") 460 mm (18.1")	386 mm (15.2") (AL ADS) 374 mm (14.7") (SS ADS) 522 mm (20.5")* (AL ADS) 509 mm (20.0")* (SS ADS)
	PS15 HS PS15 HS w/swivel	Stainless Steel	76 mm (3")	76 mm (3")	•	•	•	98 kg (216 lb)	19 mm (3/4")	1194 mm (47.0") 1221 mm (48.1")	598 mm (23.5") 649 mm (23.5")	386 mm (15.2")* (AL ADS) 374 mm (14.7")* (SS ADS) 522 mm (20.5")* (AL ADS) 509 mm (20.0")* (SS ADS)
PRO-FLO X™ HYGIENIC	PX2 HS PX2 HS w/swivel	Stainless Steel	25 mm (1")	25 mm (1")	•	•	•	40 kg (88 lb)	13 mm (1/2") FNPT	587 mm (23.1") 775 mm (30.5")	343 mm (13.5") 401 mm (15.8")	292 mm (11.5")* 480 mm (18.9")*
	PX4 HS PX4 HS w/swivel	Stainless Steel	38 mm (1-1/2")	38 mm (1-1/2")	•	•	•	51 kg (112 lb)	19 mm (3/4") FNPT	759 mm (29.9") 864 mm (34.0")	447 mm (17.6") 447 mm (17.6")	363 mm (14.3")* 498 mm (19.6")*
	PX8 HS PX8 HS w/swivel	Stainless Steel	51 mm (2")	51 mm (2")	•	•	•	49 kg (109 lb)	19 mm (3/4") FNPT	955 mm (37.6") 989 mm (38.9")	460 mm (18.1") 460 mm (18.1")	363 mm (14.3")* 498 mm (19.6")*
	PX15 HS PX15 HS w/swivel	Stainless Steel	76 mm (3")	77 mm (3")	•	•	•	98 kg (216 lb)	19 mm (3/4") FNPT	1194 mm (47.0") 1228 mm (48.4")	602 mm (23.7") 602 mm (23.7")	363 mm (14.3")* 498 mm (19.6")*
	H1500 15	Stainless Steel	76 mm (3")	76 mm (3")	•	-	-	115 kg (254 lb)	19 mm (3/4")	1204 mm (47.4")	599 mm (23.6")	490 mm (19.3")

*Dimension does not include muffler. ** Solids passage is using flap valves. *** Using PTFE IPD diaphragms.

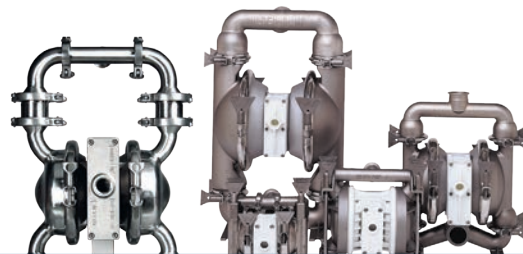

PERFORMANCE

MAX. SUCTION LIFT

MAX. DISCHARGE PRESSURE	MAX. SOLIDS PASSAGE	RUBBER/TPE		PTFE		MAX. FLOW	
		DRY	WET	DRY	WET	RUBBER/TPE	PTFE
8.6 bar (125 psig)	12.7 mm (1/2")	5.3 m (17.3')	9.0 m (29.5')	5.4 m (17.6')	9.0 m (29.5')	357 lpm (94 gpm)	357 lpm (94 gpm)
8.6 bar (125 psig)	12.7 mm (1/2")	4.1 m (13.6')	9.0 m (29.5')	3.9 m (12.7')	9.0 m (29.5')	575 lpm (151 gpm)	534 lpm (141 gpm)
8.6 bar (125 psig)	60.3 mm (2-3/8")**	4.4 m Dry (14.5')	9.0 m Wet (29.5')	4.0 m Dry (13.1')	9.0 m Wet (29.5')	844 lpm (223 gpm)	749 lpm (198 gpm)
8.6 bar (125 psig)	6.4 mm (1/4")	4.0 m (13.2')	8.6 m (28.4')	3.5 m (11.4')	8.6 m (28.4')	155 lpm (41 gpm)	153 lpm (39.6 gpm)***
8.6 bar (125 psig)	12.7 mm (1/2")	4.5 m (14.8')	9.0 (29.5')	5.9 m (19.3')	8.6 m (28.4')	367 lpm (97 gpm)	354 lpm (94 gpm)***
8.6 bar (125 psig)	47.5 mm (1-7/8")**	5.3 m (17.3')	9.0 m (29.5')	4.8 m (15.9')	8.6 m (28.4')	587 lpm (155 gpm)	556 lpm (147 gpm)
8.6 bar (125 psig)	76.2 mm (3")**	4.5 m (14.8')	8.6 m (28.4')	4.7 m (15.3')	8.6 m (28.4')	892 lpm (235 gpm)	857 lpm (226 gpm)
8.6 bar (125 psig)	6.4 mm (1/4")	3.8 m (12.5')	9.0 m (29.5')	-	-	291 lpm (77 gpm)	-

PRO-FLO® SHIFT HYGIENIC

PRO-FLO X™ HYGIENIC



METAL TECHNICAL SPECS

SIZING CONSIDERATIONS

	MODEL	WETTED MATERIALS	LIQUID INLET	LIQUID DISCHARGE	CONNECTION TYPE			SHIPPING WEIGHT	AIR INLET	HEIGHT	WIDTH	DEPTH
					TRI-CLAMP STYLE	DIN 3267 ISO 1145	SMS 1145					
PRO-FLO® SHIFT FDA	PS4 FDA	Stainless Steel	38 mm (1-1/2")	32 mm (1-1/4")	•	-	-	28 kg (62 lb)	19 mm (3/4") FNPT	429 mm (16.9")	368 mm (14.5")	340 mm (13.4")* (AL ADS) 327 mm (12.9")* (SS ADS)
	PS8 FDA	Stainless Steel	51 mm (2")	51 mm (2")	•	-	-	53 kg (117 lb)	19 mm (3/4") FNPT	668 mm (26.3")	404 mm (15.9")	351 mm (13.8")* (AL ADS) 339 mm (13.3")* (SS ADS)
	PS15 FDA	Stainless Steel	76 mm (3")	76 mm (3")	•	-	-	105 kg (230 lb)	19 mm (3/4") FNPT	815 mm (32.1")	513 mm (20.2")	424 mm (16.7")*
PRO-FLO X™ FDA	PX1 FDA	Stainless Steel	25 mm (1")	25 mm (1")	•	-	-	9 kg (20 lb)	13 mm (1/2")	257 mm (10.1")	203 mm (8.0")	386 mm (15.2")
	PX4 FDA	Stainless Steel	51 mm (2")	51 mm (2")	•	-	-	20 kg (45 lb)	19 mm (3/4")	442 mm (17.4")	396 mm (15.6")	531 mm (20.9")
	PX8 FDA	Stainless Steel	63 mm (2-1/2")	63 mm (2-1/2")	•	-	-	53 kg (117 lb)	19 mm (3/4")	665 mm (26.2")	409 mm (16.1")	551 mm (21.7")
	PX15 FDA	Stainless Steel	76 mm (3")	76 mm (3")	•	-	-	90 kg (198 lb)	19 mm (3/4")	810 mm (31.9")	521 mm (20.5")	599 mm (23.6")
PRO-FLO™ FDA	P1 FDA	Stainless Steel	25 mm (1")	25 mm (1")	•	-	-	9 kg (20 lb)	6 mm (1/4")	257 mm (10.1")	203 mm (8.0")	287 mm (11.3")
	P2 FDA	Stainless Steel	38 mm (1-1/2")	38 mm (1-1/2")	•	-	-	17 kg (37 lb)	6 mm (1/4")	284 mm (11.2")	274 mm (10.8")	310 mm (12.2")
	P4 FDA	Stainless Steel	51 mm (2")	51 mm (2")	•	-	-	20 kg (45 lb)	13 mm (1/2")	442 mm (17.4")	389 mm (15.3")	308 mm (12.1")
	P8 FDA	Stainless Steel	64 mm (2-1/2")	64 mm (2-1/2")	•	-	-	51 kg (112 lb)	13 mm (1/2")	664 mm (26.2")	434 mm (17.1")	345 mm (13.6")

*Dimension does not include muffler. ** Solids passage is using flap valves. *** Using PTFE IPD diaphragms.

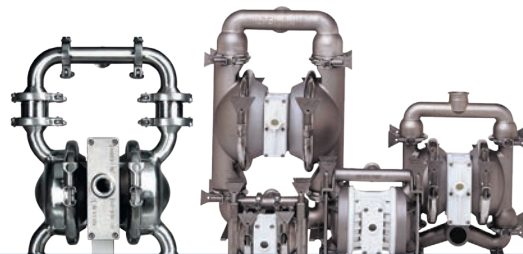

PERFORMANCE

MAX. SUCTION LIFT

MAX. DISCHARGE PRESSURE	MAX. SOLIDS PASSAGE	RUBBER/TPE		PTFE		MAX. FLOW		
		DRY	WET	DRY	WET	RUBBER/TPE	PTFE	
8.6 bar (125 psig)	4.8 mm (3/16")	7.1 m (23.3')	8.6 m (28.4')	7.0 m (22.9')	8.6 m (28.4')	314 lpm (83 gpm)	375 lpm (99 gpm)	PRO-FLO® SHIFTFDA
8.6 bar (125 psig)	6.4 mm (1/4")	7.2 m (23.8')	9.0 m (29.5')	6.3 m (20.7')	8.6 m (28.4')	719 lpm (190 gpm)	723 lpm (191 gpm)	
8.6 bar (125 psig)	9.5 mm (3/8")	6.6 m (21.6')	8.6 m (28.4')	6.2 m (20.2')	8.6 m (28.4')	927 lpm (245 gpm)	916 lpm (242 gpm)	
8.6 bar (125 psig)	1.6 mm (1/16")	5.9 m (19.3')	8.0 m (26.2')	4.7 m (15.3')	8.0 m (26.1')	62.8 lpm (16.5 gpm)	60.9 lpm (16.1 gpm)	PRO-FLO X™ FDA
8.6 bar (125 psig)	4.8 mm (3/16")	6.0 m (19.7')	9.3 m (30.6')	6.7 m (22.1')	9.3 m (30.6')	347 lpm (92 gpm)	327 lpm (87 gpm)	
8.6 bar (125 psig)	6.4 mm (1/4")	7.1 m (23.3')	8.6 m (28.4')	6.7 m (22.1')	9.0 m (29.5')	675 lpm (178 gpm)	703 lpm (186 gpm)	
8.6 bar (125 psig)	9.5 mm (3/8")	6.7 m (22.1')	9.5 m (31.2')	6.6 m (21.6')	9.0 m (29.5')	918 lpm (243 gpm)	902 lpm (238 gpm)	
8.6 bar (125 psig)	1.6 mm (1/16")	5.8 m (19.0')	9.5 m (31.0')	4.9 m (16.0')	9.5 m (31.0')	58.7 lpm (15.5 gpm)	54.4 lpm (14.4 gpm)	PRO-FLO™ FDA
8.6 bar (125 psig)	3.2 mm (1/8")	7.6 m (25.0')	9.0 m (29.5')	4.7 m (15.3')	9.0 m (29.5')	172 lpm (45.5 gpm)	167 lpm (44.1 gpm)	
8.6 bar (125 psig)	4.8 mm (3/16")	5.8 m (19.0')	8.0 m (26.0')	6.4 m (21.0')	9.3 m (30.6')	307 lpm (81 gpm)	330 lpm (87.2 gpm)	
8.6 bar (125 psig)	6.4 mm (1/4")	6.9 m (22.7')	8.6 m (28.4')	6.7 m (22.1')	9.0 m (29.5')	630 lpm (166 gpm)	618 lpm (163 gpm)	

Where Innovation Flows

WILDEN[®]

PSG
22069 Van Buren Street
Grand Terrace, CA 92313-5651 USA
P: +1 (909) 422-1730 • F: +1 (909) 783-3440
wildenpump.com

PSG[®] reserves the right to modify the information and illustrations contained in this document without prior notice. This is a non-contractual document. 09-2015

Authorized PSG Partner: