

CombiPrime

Self-priming centrifugal pumps

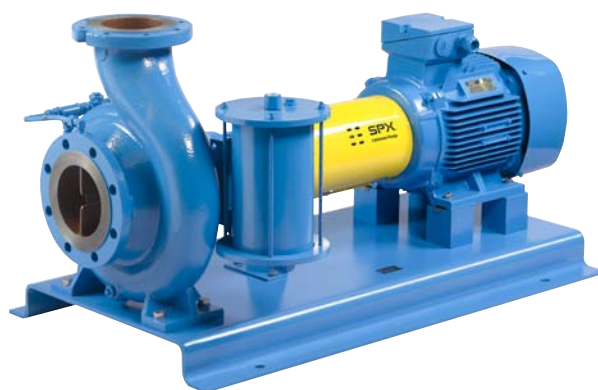

The SPX Johnson Pump Combi system is a modular programme of single stage centrifugal pumps with a high degree of interchangeability of parts between the different pump constructions.

The Combi pumps cover an extensive series of centrifugal pumps which can be supplied as horizontal, vertical and submerged pumps. A number of standards were taken into account in the designing of this pump series; EN 733 (DIN 24255), EN 22858 (ISO 2858 / DIN 24256), ISO 5199 and API 610.

Based in Charlotte, North Carolina, SPX Corporation (NYSE: SPW) is a global Fortune 500 multi-industry manufacturing leader with over \$5 billion in annual revenue, operations in more than 35 countries and over 15,000 employees. The company's highly-specialized, engineered products and technologies are concentrated in Flow Technology and energy infrastructure. Many of SPX's innovative solutions are playing a role in helping to meet rising global demand for electricity and processed foods and beverages, particularly in emerging markets. The company's products include food processing systems for the food and beverage industry, power transformers for utility companies, and cooling systems for power plants. For more information, please visit www.spx.com.

CombiPrime Self-priming centrifugal pumps

CombiPrime is a series of self-priming centrifugal pumps, suited for pumping clean or slightly polluted liquids, with low viscosity. The pumps are available in horizontal as well as in vertical construction. The pump's self-priming ability is performed by a built-in vacuum pump, based upon the liquid ring principle.

The most important characteristic of the CombiPrime is the built-in vacuum pump. This makes it possible to pump a liquid/air mixture or exclusively air during the suction phase. The built-in vacuum pump is based on the liquid ring principle.

The CombiPrime is used when handling vapour, aerated liquids or air during the priming stage. The availability of several material options enables corrosive media to be pumped. Applications: bilge and ballast pumps in shipping, fire extinguishing, sprinkler sets.

Maintenance is simplified because of the applied 'Back Pull Out'-principle for the horizontal and 'Top Pull Out'-principle for the vertical construction.



Test bed SPX Flow Technology in Assen, the Netherlands

CombiPrime



CombiPrime H



CombiPrime V

PUMP CHARACTERISTICS

- Self-priming
- Always ready for direct use
- Available in horizontal or vertical construction
- Sea water resistant version available
- High pump efficiency
- Suitable for a wide span of duties
- Rigid construction
- Back/Top Pull Out principle
- Easy maintenance

TECHNICAL DATA	CH	CV
MAX. CAPACITY	500 M ³ /H	800 M ³ /H
MAX. HEAD	100 M	
MAX. WORKING PRESSURE	10 BAR	
MAX. TEMPERATURE	80 °C	
MAX. SPEED	3600 RPM	
MAX. SUCTION LIFT	8 M	

Typical product applications

When reliable, direct duty is of 'prime' importance!

SHIPBUILDING

CombiPrime pumps can handle fresh water as well as sea water, both clean and slightly contaminated. Common applications aboard ships are fire-fighting and general duty pumping. The space-saving vertical construction of the CombiPrime V is one more benefit that serves well in the narrow spaced machine rooms.

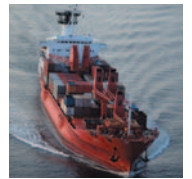

GENERAL INDUSTRIAL DUTY

CombiPrime pumps can be used for skid-mounted fire-fighting units as well as in fresh water supply units in the field.





COMBIPRIME H

PUMP CASING

- hydraulic performance meet EN 733 (DIN 24255)
- flange connections according to EN 1092-2 ND 10 (DIN 2532).
- replaceable wear ring
- smooth suction entry
- *large application area*
- *longer duty life*
- *better suction capabilities*

Features and *benefits*

EXTERNAL PARTS

- all external parts connected with the self-priming stage of the pump are made of stainless steel
- *reliable operation in all circumstances*

IMPELLER

- closed impeller
- back vanes for hydraulic balancing
- impeller cap nut in bronze
- *better suction capabilities*
- *low axial forces resulting in extended bearing life*
- *reliable impeller locking*

BEARING

- consisting of one roller bearing and two angular contact ball bearings
- adjustable bearing container
- *excellent absorption of axial thrust*
- *exact shaft positioning in order to adjust the vacuum pumps' air wheel*

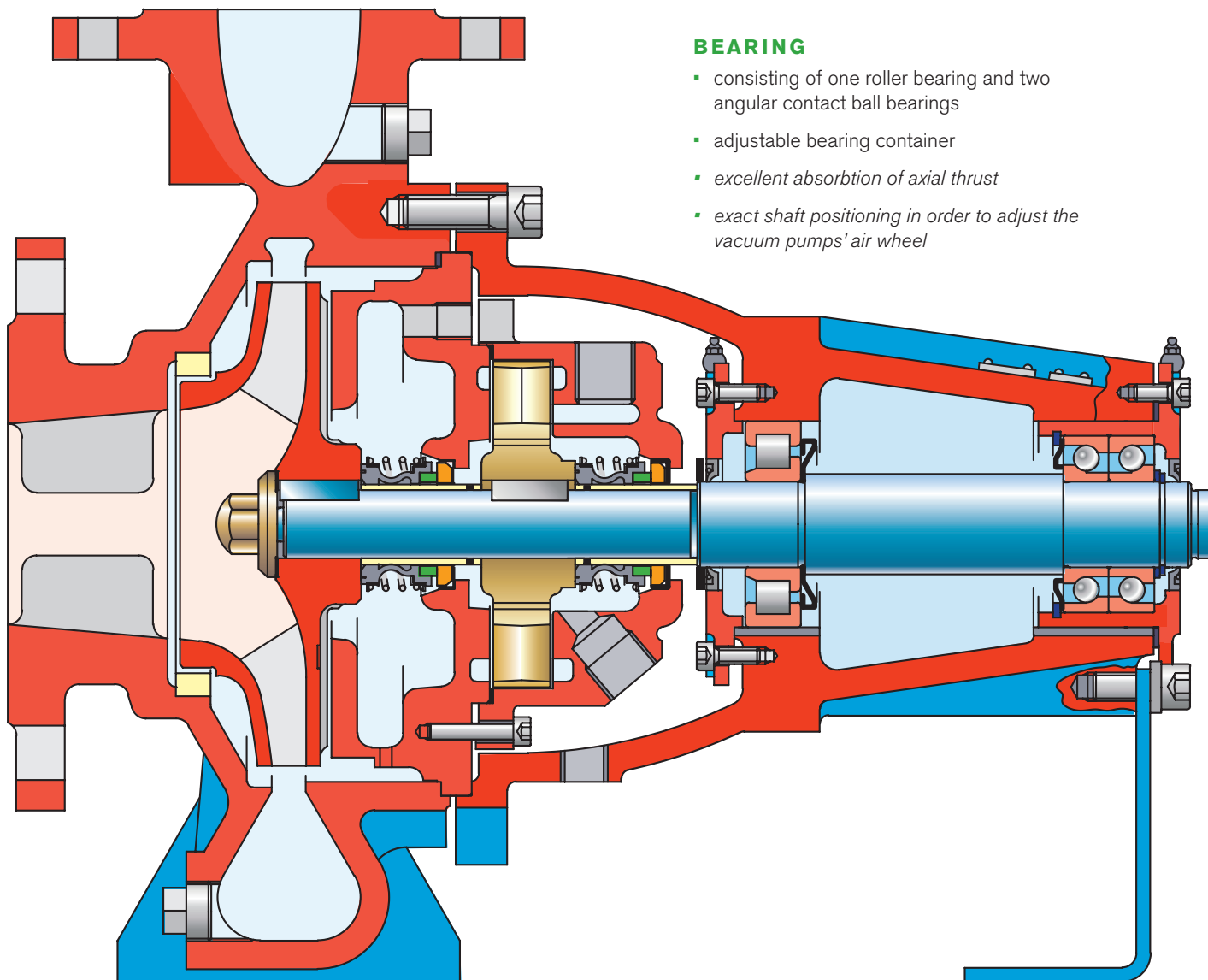

BEARINGS

- grease lubricated bearing construction
- roller bearing at pump end
- two paired angular contact ball bearings at drive end
- adjustable in axial direction for adjustment self-priming wheel
- long bearing life time

SHAFT SEALING

- mechanical seals with bellows according EN 12756 (DIN 24960), on shaft sleeves
- lip seals, running on shaft sleeves with hardened wear-resistant layers
- standard EN(DIN) seal makes
- shaft sealing option for liquids containing abrasive particles

VACUUM PUMP

- operates according to liquid ring principle
- externally connected to service liquid supply
- cover and air wheel in bronze
- always ready for priming duty
- quick self-priming operation
- large application area

PUMP SHAFT

- stainless steel AISI 316 or steel alloy
- adequate corrosion resistancy

FOOT

- rigid steel profiles
- machined foot
- sturdy, reliable construction
- exact positioning on base and in pipework

COMBIPRIME V

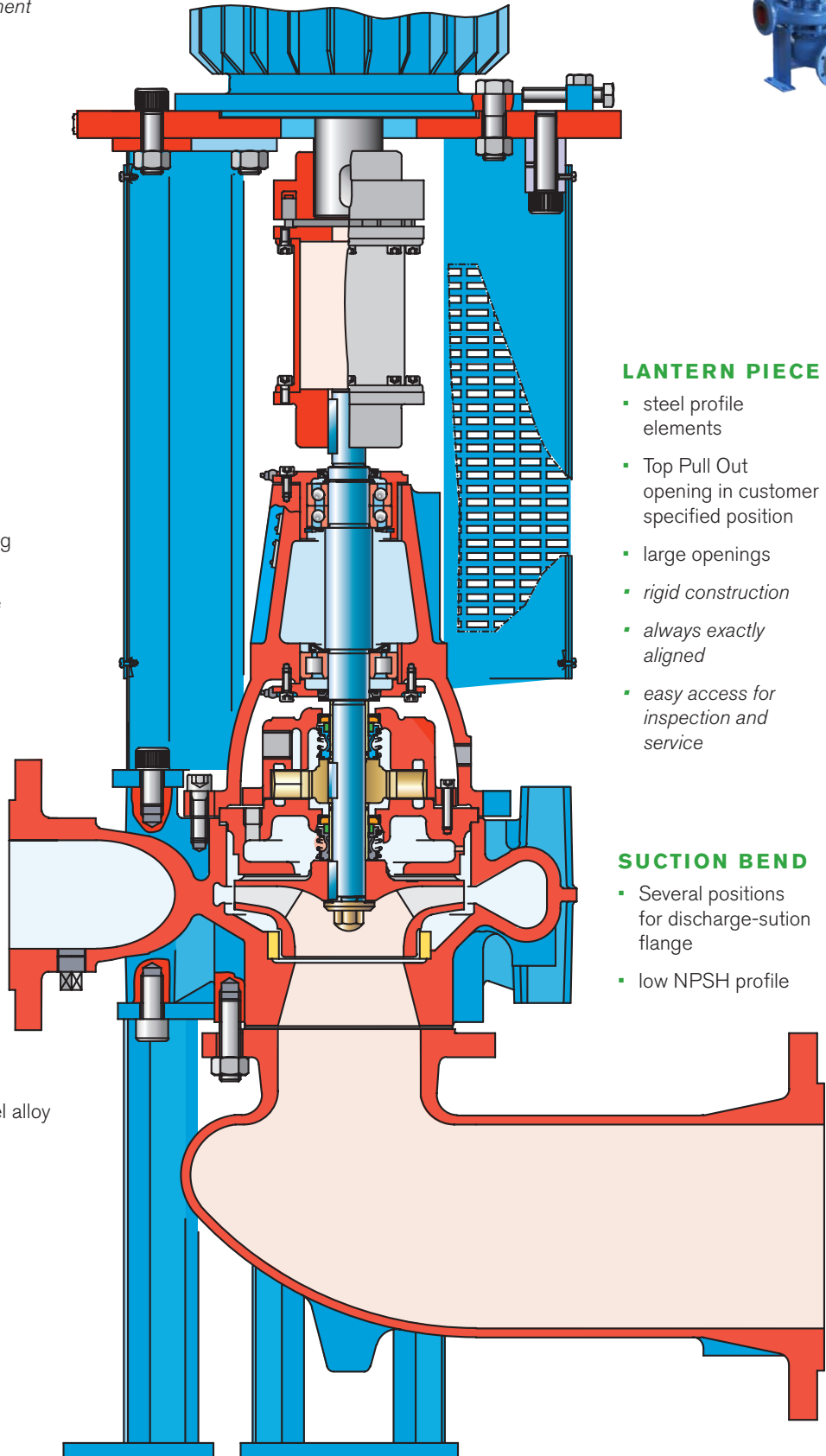

LANTERN PIECE

- steel profile elements
- Top Pull Out opening in customer specified position
- large openings
- rigid construction
- always exactly aligned
- easy access for inspection and service

SUCTION BEND

- Several positions for discharge-suction flange
- low NPSH profile

Built-in vacuum pump

The built-in vacuum pump makes it possible to pump a liquid/air mixture or exclusively air during the suction phase. Vacuum and centrifugal pumps use the same drive mechanism, but they operate independently. This makes the CombiPrime extremely flexible, with regard to both application and installation. To maintain adequate operation of the vacuum pump a sufficient supply of service liquid to the vacuum pump is necessary. Excess service liquid is drained. There are 2 ways of doing this:

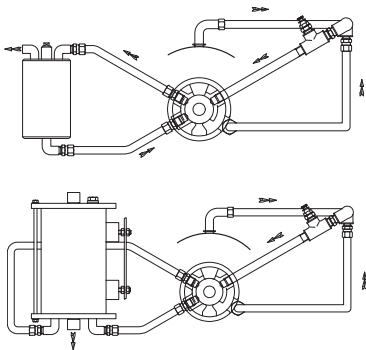

- **a service liquid tank**, where liquid and air are being separated and vented and drained outside the system
- **a float de-aerating tank**, where liquid and air are being separated. The excess liquid is being returned to the line system

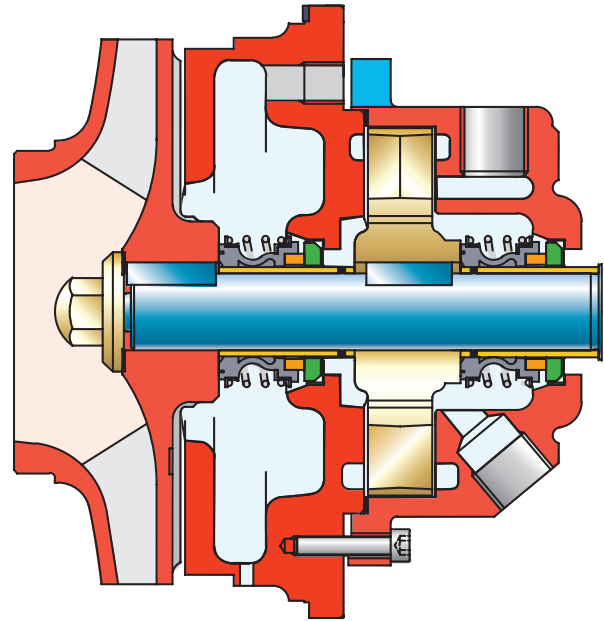

Shaft sealing

The CombiPrime can be provided with either 2 mechanical seals or 5 lip seal rings. They are mounted on shaft sleeves, which in case of a lip seal assembly are provided with a hardened wear layer.

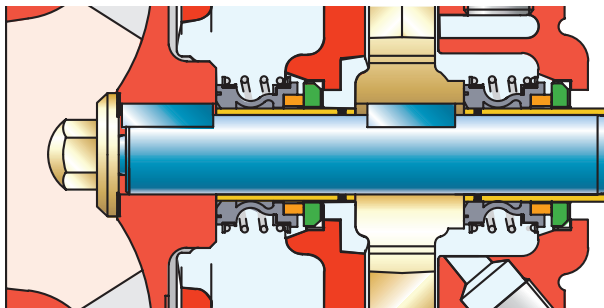

Mechanical seals

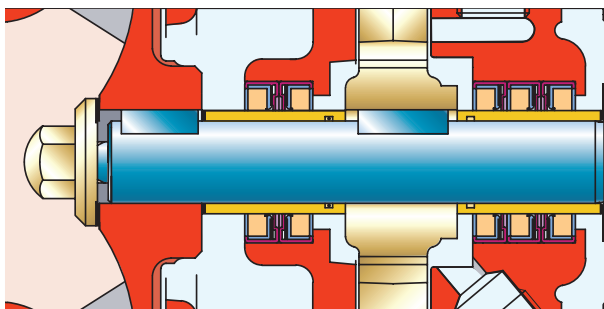

Lip seal rings

Bearing

The bearing of the CombiPrime consists of 2 angular contact ball bearings and a roller bearing. The bearing covers are provided with grease nipples for periodical post-greasing.

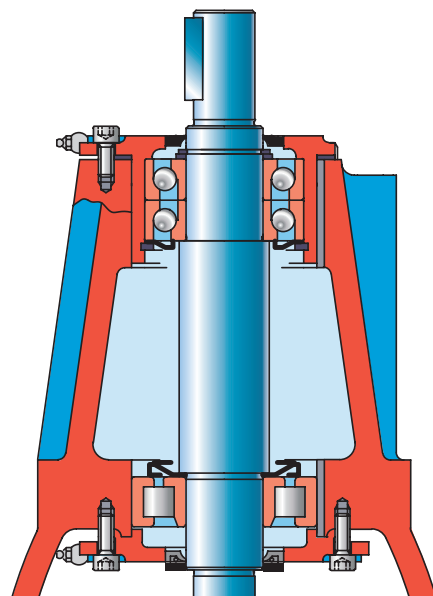

Pump performance

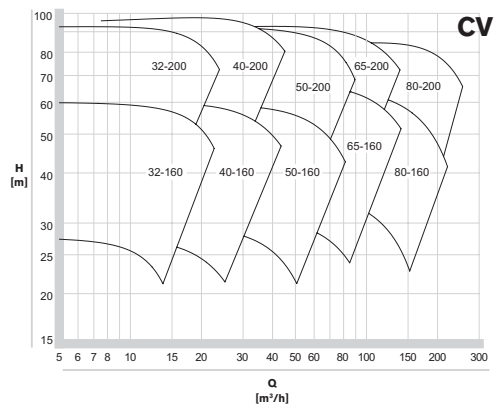
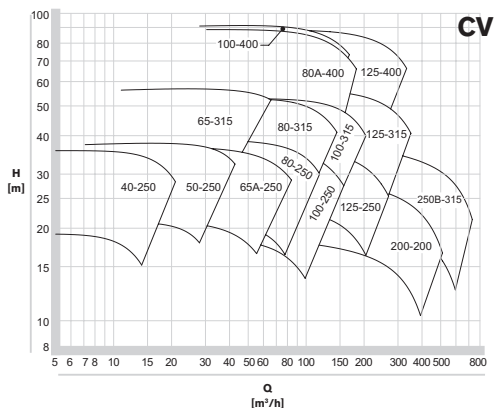
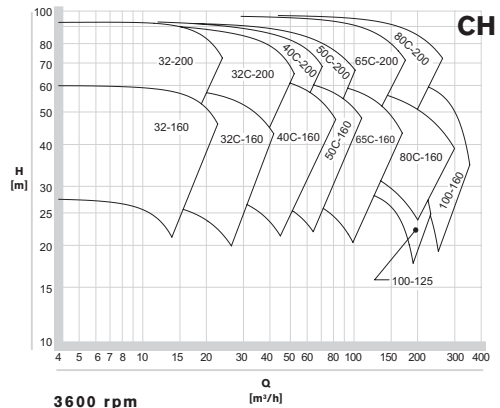
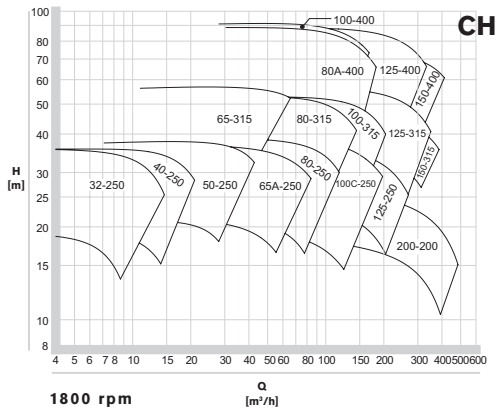
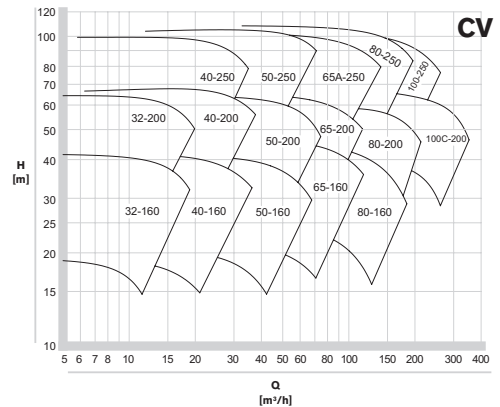
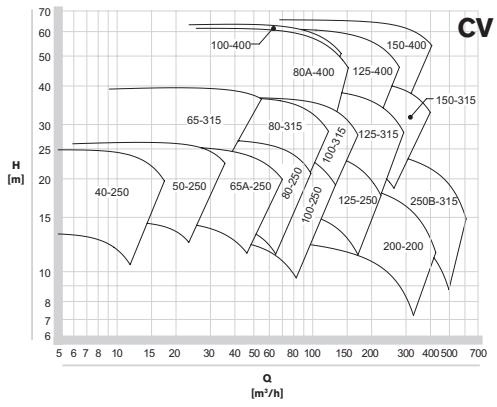
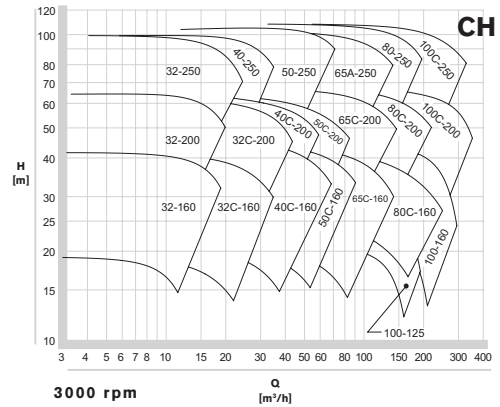
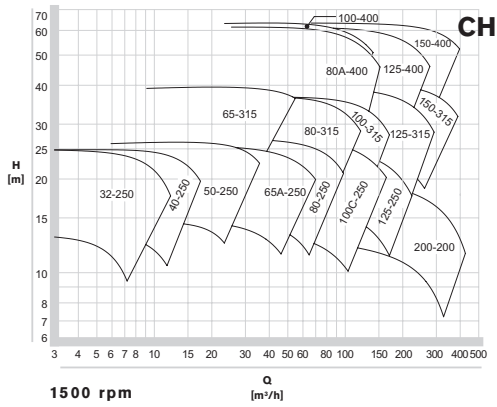

Subject to alterations



CombiPrime

Self-priming centrifugal pumps

Your local contact:

http://www.johnson-pump.com/JPIIndustry/JohnsonPump_distributors.htm

SPX FLOW TECHNOLOGY ASSEN B.V.

Dr. A.F. Philipsweg 51, 9403 AD Assen

P.O. Box 9, 9400 AA Assen, THE NETHERLANDS

P: +31 (0)592 37 67 67

F: +31 (0)592 37 67 60

E: johnson-pump.nl@spx.com

SPX reserves the right to incorporate our latest design and material changes without notice or obligation.

Design features, materials of construction and dimensional data, as described in this bulletin, are provided for your information only and should not be relied upon unless confirmed in writing. Please contact your local sales representative for product availability in your region. For more information visit www.spx.com and www.johnson-pump.com.

The green ">" is a trademark of SPX Corporation, Inc..

ISSUED 12/2012 JP-CHCV-EN

COPYRIGHT © 2009, 2012 SPX Corporation