

PX8

Saniflo™ Hygienic Series **METAL** Pumps

EOM

Engineering
Operation &
Maintenance



Refine your process

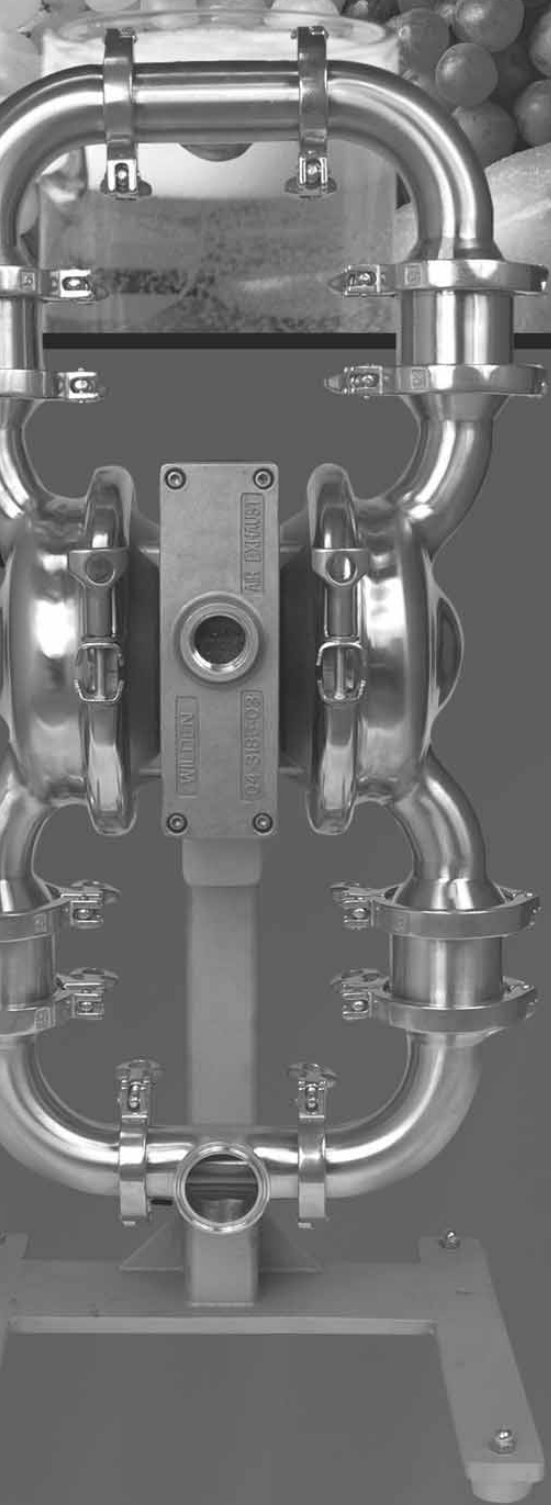

TYPE EL
SEPTEMBER 2005



WILDEN®

A DOVER COMPANY



WIL-12310-E-01

TABLE OF CONTENTS

SECTION 1 CAUTIONS—READ FIRST!1

SECTION 2 WILDEN PUMP DESIGNATION SYSTEM2

SECTION 3 HOW IT WORKS—PUMP & AIR DISTRIBUTION SYSTEM3

SECTION 4 DIMENSIONAL DRAWINGS4

SECTION 5 PERFORMANCE

 A. PX8 Performance Curves

 Rubber-Fitted12

 TPE-Fitted13

 PTFE-Fitted14

 Ultra-Flex™ -Fitted15

 SIPD-Fitted16

 B. Suction Lift Curves17

SECTION 6 SUGGESTED INSTALLATION, OPERATION & TROUBLESHOOTING19

SECTION 7 ASSEMBLY / DISASSEMBLY22

SECTION 8 CLEANING - CIP31

SECTION 9 EXPLODED VIEW & PARTS LISTING



















 PX8 Saniflo™ HS32

 PX8 Saniflo™ HS (Nickel Plated ADS).....33

 PX8 Saniflo™ HS (Stainless Steel ADS)34

SECTION 10 ELASTOMER OPTIONS35

CAUTIONS—READ FIRST!

-  **CAUTION:** Do not apply compressed air to the exhaust port — pump will not function.
-  **CAUTION:** Do not over-lubricate air supply — excess lubrication will reduce pump performance. Pump is pre-lubed.
-  **TEMPERATURE LIMITS:**
- | | | |
|---|--------------------|----------------|
| Neoprene | -17.7°C to 93.3°C | 0°F to 200°F |
| Buna-N | -12.2°C to 82.2°C | 10°F to 180°F |
| Nordel [®] | -51.1°C to 137.8°C | -60°F to 280°F |
| Viton [®] | -40°C to 176.7°C | -40°F to 350°F |
| Saniflex [™] | -28.9°C to 104.4°C | -20°F to 220°F |
| Polytetrafluoroethylene (PTFE) | | |
| | 4.4°C to 104.4°C | 40°F to 220°F |
| Polyurethane | -12.2°C to 65.6°C | 10°F to 150°F |
| Tetra-Flex [™] PTFE w/Neoprene Backed | | |
| | 4.4°C to 107.2°C | 40°F to 225°F |
| Tetra-Flex [™] PTFE w/Nordel [®] Backed | | |
| | -10°C to 137°C | 14°F to 280°F |
| Wil-Flex [™] (Santoprene [®]) | | |
| | -40°C to 107.2°C | -40°F to 225°F |
- NOTE: Not all materials are available for all models. Refer to Section 2 for material options for your pump.
-  **CAUTION:** When choosing pump materials, be sure to check the temperature limits for all wetted components. Example: Viton[®] has a maximum limit of 176.7°C (350°F) but polypropylene has a maximum limit of only 79°C (175°F).
-  **CAUTION:** Maximum temperature limits are based upon mechanical stress only. Certain chemicals will significantly reduce maximum safe operating temperatures. Consult Chemical Resistance Guide (E4) for chemical compatibility and temperature limits.
-  **WARNING:** Prevention of static sparking — If static sparking occurs, fire or explosion could result. Pump, valves, and containers must be grounded to a proper grounding point when handling flammable fluids and whenever discharge of static electricity is a hazard.
-  **CAUTION:** Do not exceed 8.6 bar (125 psig) air supply pressure.
-  **CAUTION:** The process fluid and cleaning fluids must be chemically compatible with all wetted pump components. Consult Chemical Resistance Guide (E4).
-  **CAUTION:** Do not exceed 82°C (180°F) air inlet temperature for Pro-Flo V[™] models.
-  **CAUTION:** Pumps should be thoroughly flushed before installing into process lines. FDA and USDA approved pumps should be cleaned and/or sanitized before being used.
-  **CAUTION:** Always wear safety glasses when operating pump. If diaphragm rupture occurs, material being pumped may be forced out air exhaust.
-  **CAUTION:** Before any maintenance or repair is attempted, the compressed air line to the pump should be disconnected and all air pressure allowed to bleed from pump. Disconnect all intake, discharge and air lines. Drain the pump by turning it upside down and allowing any fluid to flow into a suitable container.
-  **CAUTION:** Blow out air line for 10 to 20 seconds before attaching to pump to make sure all pipeline debris is clear. Use an in-line air filter. A 5μ (micron) air filter is recommended.
-  **NOTE:** When installing PTFE diaphragms, it is important to tighten outer pistons simultaneously (turning in opposite directions) to ensure tight fit. (See torque specifications in Section 7.)
-  **NOTE:** Cast Iron PTFE-fitted pumps come standard from the factory with expanded PTFE gaskets installed in the diaphragm bead of the liquid chamber. PTFE gaskets cannot be re-used. Consult PS-TG for installation instructions during reassembly.
-  **NOTE:** Before starting disassembly, mark a line from each liquid chamber to its corresponding air chamber. This line will assist in proper alignment during reassembly.
-  **CAUTION:** Pro-Flo[®] pumps cannot be used in submersible applications. Pro-Flo V[™] and Pro-Flo X[™] are available in both submersible and non-submersible options. Do not use non-submersible Pro-Flo V[™] or Pro-Flo X[™] models in submersible applications. Turbo-Flo[®] pumps can also be used in submersible applications.
-  **CAUTION:** Tighten all hardware prior to installation.



WILDEN PUMP DESIGNATION SYSTEM

**PX8 SANIFLO™
HYGIENIC SERIES**

**51 mm (2") Pump
Maximum Flow Rate:
587 lpm (155 gpm)**

LEGEND

PX8 / XXXXX / XXX / XX / XX / XXXX

MODEL

GASKETS

SPECIALTY
CODE
(if applicable)

DIAPHRAGMS
VALVE OPTION
AIR VALVE
AIR CHAMBER
CENTER SECTION
WETTED PARTS & OUTER PISTON

MATERIAL CODES

MODEL

PX8 = 51 mm (2")
XPX8 = 51 mm (2") ATEX

**WETTED PARTS/
OUTER PISTON**

SS = 316L STAINLESS STEEL
SZ = 316L STAINLESS STEEL/
NO PISTON

CENTER BLOCK

N = NICKEL PLATED ALUMINUM
S = 316 STAINLESS STEEL

AIR CHAMBERS

N = NICKEL PLATED ALUMINUM
S = 316 STAINLESS STEEL

AIR VALVE

N = NICKEL PLATED ALUMINUM
S = 316 STAINLESS STEEL

DIAPHRAGMS

BNU = ULTRA-FLEX™ BUNA^{1,5}
EPU = ULTRA-FLEX™ EPDM^{1,5}
FBS = SANITARY BUNA¹
(two yellow dots)
FES = SANITARY EPDM¹
(two blue dots)
FSS = SANIFLEX™¹
FWS = SANITARY WIL-FLEX™¹
LEL = PTFE-EPDM BACKED
LAMINATE IPD^{1,2,3,4,5}
TEU = PTFE w/EPDM BACKUP^{1,2,5}
TSU = PTFE w/SANIFLEX™
BACK-UP^{1,2,5}

**VALVE BALLS, FLAP VALVES,
MUSHROOM CHECK**

FB = SANITARY BUNA^{1,3,4}
(red dot)
FE = SANITARY EPDM^{1,3,4}
(green dot)
FS = SANIFLEX™^{1,3,4}
FW = SANITARY WIL-FLEX™^{1,3,4}
SF = STAINLESS STEEL FLAP^{1,5}
TF = PTFE^{1,2,3,4}
TM = PTFE MUSHROOM
CHECK^{1,2}

MANIFOLD GASKET

FB = SANITARY BUNA-N^{1,3,4}
(red dot)
FE = SANITARY EPDM^{1,3,4}
(green dot)
FV = SANITARY VITON®^{1,3,4}
(one white/one
yellow dots)
TF = PTFE^{1,2,3,4,5}

NOTE:

1. Meets Requirements of FDA CFR21.177
2. Meets Requirements of USPClass VI
3. Required for EHEDG Certification
4. Required for 3-A Certification
5. Stainless flap valve not available with PTFE, Ultra-Flex™ or Laminate IP diaphragms

SPECIALTY CODES

- 0770 SaniFlo HS
- 0771 SaniFlo HS, w/Swivel Stand
- 0772 SaniFlo HS, Wil-Gard 110V
- 0773 SaniFlo HS, Wil-Gard 220V
- 0774 HS, Wil-Gard 110V, w/Swivel Stand
- 0775 SaniFlo HS, Wil-Gard 220V, w/Swivel Stand
- 0778 SaniFlo HS, DIN Connection
- 0779 HS, w/Swivel Stand DIN Connection
- 0780 SaniFlo HS, Wil-Gard 110V DIN Connection

- 0781 SaniFlo HS, Wil-Gard 220V DIN Connection
- 0782 SaniFlo HS, Wil-Gard 110V, w/Swivel Stand DIN Connection
- 0783 SaniFlo HS, Wil-Gard 220V, w/Swivel Stand DIN Connection
- 0784 SaniFlo HS, SMS Connection
- 0785 SaniFlo HS, w/Swivel Stand SMS Connection
- 0786 SaniFlo HS, Wil-Gard 110V SMS Connection
- 0787 SaniFlo HS, Wil-Gard 220V SMS Connection
- 0788 SaniFlo HS, Wil-Gard 110V, w/Swivel Stand SMS Connection
- 0789 SaniFlo HS, Wil-Gard 220V, w/Swivel Stand SMS Connection

NOTE: MOST ELASTOMERIC MATERIALS USE COLORED DOTS FOR IDENTIFICATION.

Viton® is a registered trademark of DuPont Dow Elastomers.

The Wilden diaphragm pump is an air-operated, positive displacement, self-priming pump. These drawings show flow pattern through the pump upon its initial stroke. It is assumed the pump has no fluid in it prior to its initial stroke.

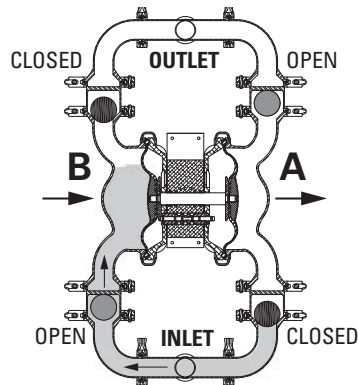

FIGURE 1 The air valve directs pressurized air to the back side of diaphragm A. The compressed air is applied directly to the liquid column separated by elastomeric diaphragms. The diaphragm acts as a separation membrane between the compressed air and liquid, balancing the load and removing mechanical stress from the diaphragm. The compressed air moves the diaphragm away from the center of the pump. The opposite diaphragm is pulled in by the shaft connected to the pressurized diaphragm. Diaphragm B is on its suction stroke; air behind the diaphragm has been forced out to atmosphere through the exhaust port of the pump. The movement of diaphragm B toward the center of the pump creates a vacuum within chamber B. Atmospheric pressure forces fluid into the inlet manifold forcing the inlet valve ball off its seat. Liquid is free to move past the inlet valve ball and fill the liquid chamber (see shaded area).

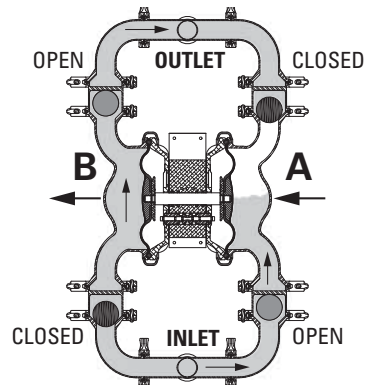

FIGURE 2 When the pressurized diaphragm, diaphragm A, reaches the limit of its discharge stroke, the air valve redirects pressurized air to the back side of diaphragm B. The pressurized air forces diaphragm B away from the center while pulling diaphragm A to the center. Diaphragm B is now on its discharge stroke. Diaphragm B forces the inlet valve ball onto its seat due to the hydraulic forces developed in the liquid chamber and manifold of the pump. These same hydraulic forces lift the discharge valve ball off its seat, forcing fluid to flow through the pump discharge. The movement of diaphragm A toward the center of the pump creates a vacuum within liquid chamber A. Atmospheric pressure forces fluid into the inlet manifold of the pump. The inlet valve ball is forced off its seat allowing the fluid being pumped to fill the liquid chamber.

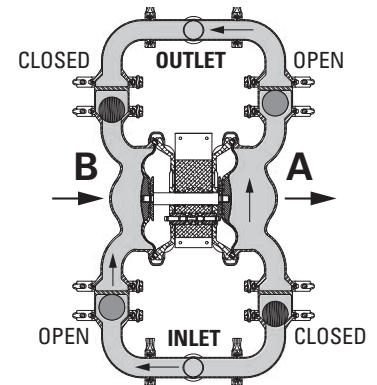
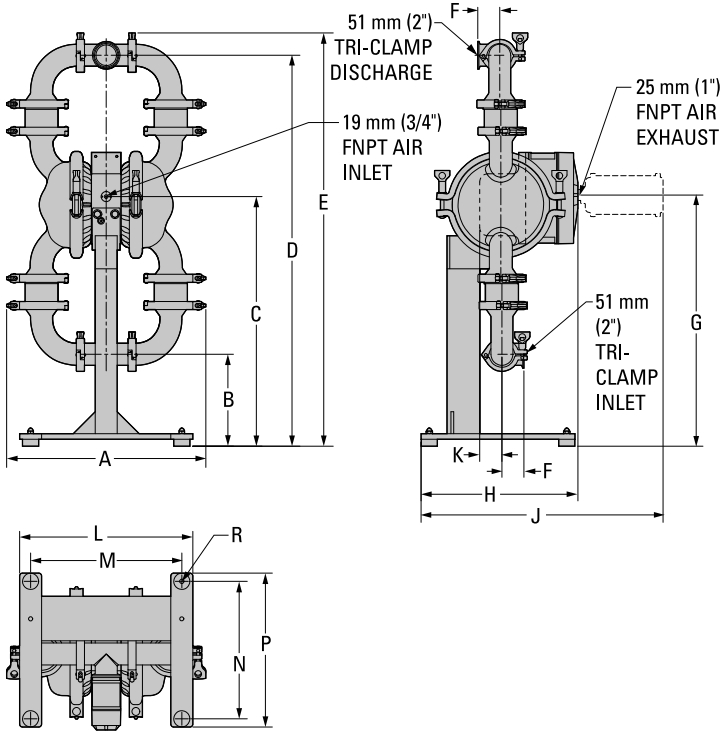

FIGURE 3 At completion of the stroke, the air valve again redirects air to the back side of diaphragm A, which starts diaphragm B on its exhaust stroke. As the pump reaches its original starting point, each diaphragm has gone through one exhaust and one discharge stroke. This constitutes one complete pumping cycle. The pump may take several cycles to completely prime depending on the conditions of the application.

PX8 Saniflo™ HS Fixed



DIMENSIONS

PX8 SANIFLO™ HS VERTICAL FIXED WITH MUSHROOM OR BALL VALVE		
ITEM	METRIC (mm)	STANDARD (inch)
A	460	18.1
B	213	8.4
C	577	22.7
D	902	35.5
E	955	37.6
F	51	2.0
G	579	22.8
H	363	14.3
J	559	22.0
K	46	1.8
L	401	15.8
M	351	13.8
N	318	12.5
P	356	14.0
R	ø10	ø0.4

Rev A

PX8 Saniflo™ HS Flap Valve Fixed

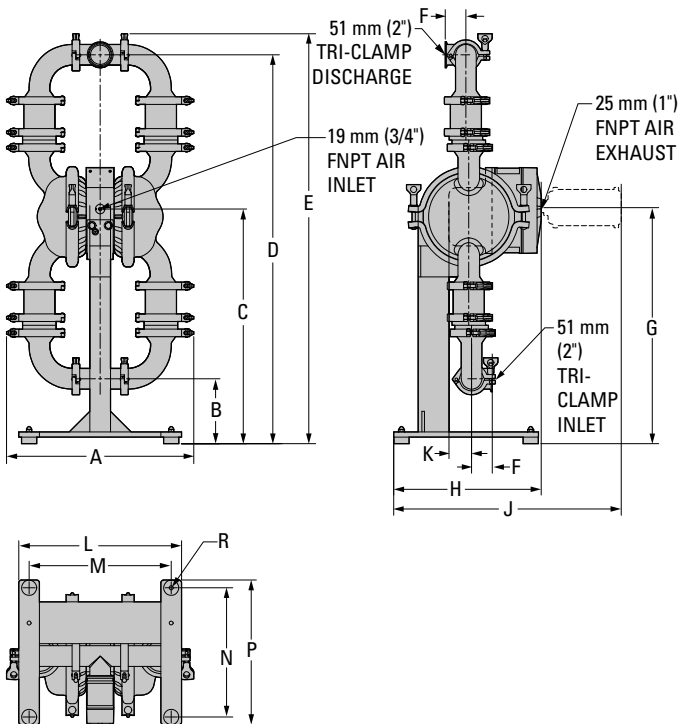

DIMENSIONS

PX8 SANIFLO™ HS VERTICAL FIXED WITH FLAP VALVE		
ITEM	METRIC (mm)	STANDARD (inch)
A	460	18.1
B	160	6.3
C	577	22.7
D	955	37.6
E	1008	39.7
F	51	2.0
G	579	22.8
H	363	14.3
J	559	22.0
K	56	2.2
L	401	15.8
M	351	13.8
N	318	12.5
P	356	14.0
R	ø10	ø0.4

Rev A

PX8 Saniflo™ HS Swivel

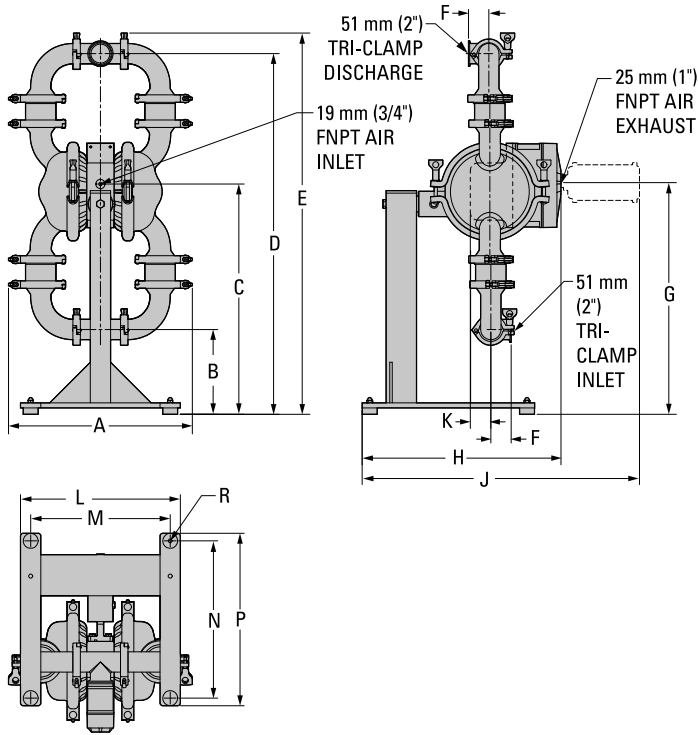

DIMENSIONS

PX8 SANIFLO™ HS VERTICAL SWIVEL WITH MUSHROOM OR BALL VALVE		
ITEM	METRIC (mm)	STANDARD (inch)
A	460	18.1
B	213	8.4
C	577	22.7
D	902	35.2
E	955	37.6
F	51	2.0
G	579	22.8
H	498	19.6
J	693	27.3
K	46	1.8
L	401	15.8
M	351	13.8
N	394	15.5
P	432	17.0
R	ø10	ø0.4

Rev A

PX8 Saniflo™ HS Flap Valve Swivel

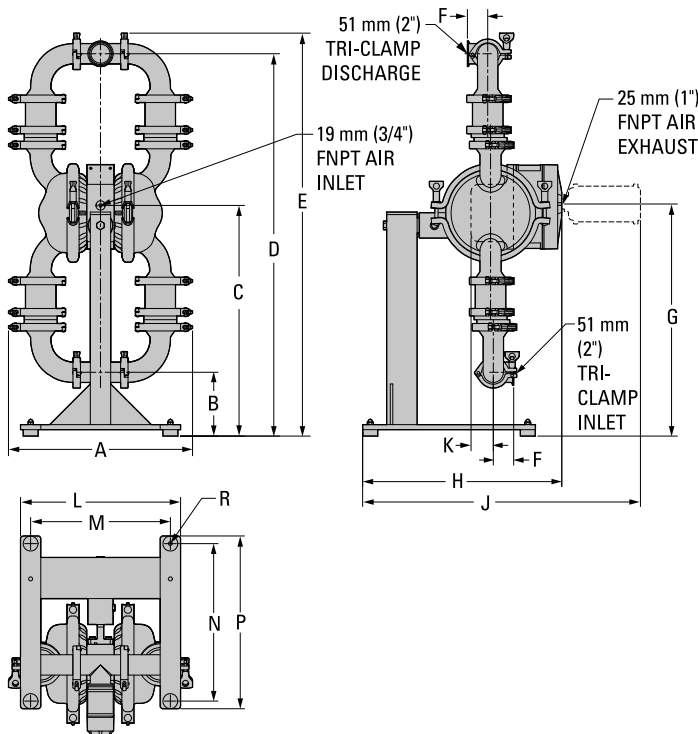

DIMENSIONS

PX8 SANIFLO™ HS VERTICAL SWIVEL WITH FLAP VALVE		
ITEM	METRIC (mm)	STANDARD (inch)
A	460	18.1
B	160	6.3
C	577	22.7
D	955	37.6
E	1008	39.7
F	51	2.0
G	579	22.8
H	498	19.6
J	693	27.3
K	56	2.2
L	401	15.8
M	351	13.8
N	394	15.5
P	432	17.0
R	ø10	ø0.4

Rev A

Pump Solids

Maximize Your Yield

Is your process limping along with a pump that wasn't designed to transfer sanitary solids? Are your inspection, cleaning, and maintenance costs too high? Are you looking for a pump that is actually designed for your application?

Wilden has your answer. The Saniflo™ VC pump can transfer your product without damage from bruising or shearing. The pump is specifically designed to meet your performance needs while minimizing cleaning and inspection time. Contact us for a unique perspective and proven results. The Saniflo™ VC will handle any food product that you can dish out.



- 3 sizes available
- Solids passage to 152 mm (6")
- Stainless steel construction
- Only 2 moving parts
- Low liquid content requirement
- Complies with USDA requirements
- Variable flow
- CE marked
- Low voltage directive by TÜV
- PED & machinery directive

WILDEN
A DOVER COMPANY

22069 VAN BUREN STREET • GRAND TERRACE, CA 92313-5607
(909) 422-1730 • FAX (909) 783-3440
www.wildenpump.com

PX8

M E T A L

WILDEN
A DOVER COMPANY



PX8 PERFORMANCE



Pro-Flo X™ Operating Principal

The Pro-Flo X™ air distribution system with the revolutionary Efficiency Management System (EMS) offers flexibility never before seen in the world of AODD pumps. The patent-pending EMS is simple and easy to use. With the turn of an integrated

control dial, the operator can select the optimal balance of flow and efficiency that best meets the application needs. Pro-Flo X™ provides higher

performance, lower operational costs and flexibility that exceeds previous industry standards.



<p>Turning the dial changes the relationship between air inlet and exhaust porting.</p>	<p>Each dial setting represents an entirely different flow curve</p>	<p>Pro-Flo X™ pumps are shipped from the factory on setting 4, which is the highest flow rate setting possible</p>	<p>Moving the dial from setting 4 causes a decrease in flow and an even greater decrease in air consumption.</p>	<p>When the air consumption decreases more than the flow rate, efficiency is improved and operating costs are reduced.</p>

Example 1

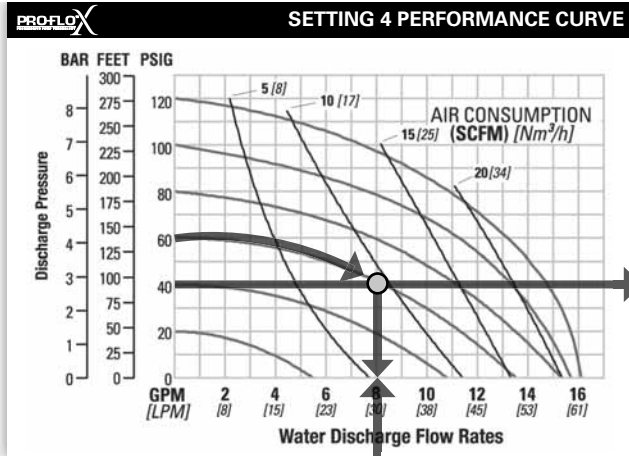

Figure 1

Example data point = **8.2** GPM

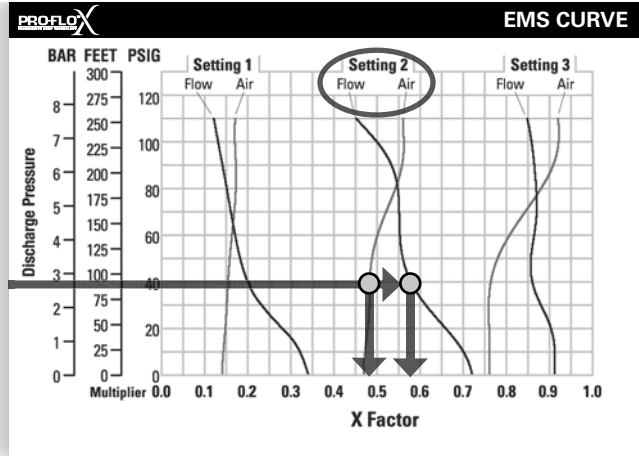

Figure 2

Example data point = **0.58** flow multiplier
0.48 air multiplier

This is an example showing how to determine flow rate and air consumption for your Pro-Flo X™ pump using the Efficiency Management System (EMS) curve and the performance curve. For this example we will be using 4.1 bar (60 psig) inlet air pressure and 2.8 bar (40 psig) discharge pressure and EMS setting 2.

Step 1: Identifying performance at setting 4. Locate the curve that represents the flow rate of the pump with 4.1 bar (60 psig) air inlet pressure. Mark the point where this curve crosses the horizontal line representing 2.8 bar (40 psig) discharge pressure. (Figure 1). After locating your performance point on the flow curve, draw a vertical line downward until reaching the bottom scale on the chart. Identify the flow rate (in this case, 8.2 gpm). Observe location of performance point relative to air consumption curves and approximate air consumption value (in this case, 9.8 scfm).

Step 2: Determining flow and air X Factors. Locate your discharge pressure (40 psig) on the vertical axis of the EMS curve (Figure 2). Follow along the 2.8 bar (40 psig) horizontal line until intersecting both flow and air curves for your desired EMS setting (in this case, setting 2). Mark the points where the EMS curves intersect the horizontal discharge pressure line. After locating your EMS points on the EMS

curve, draw vertical lines downward until reaching the bottom scale on the chart. This identifies the flow X Factor (in this case, 0.58) and air X Factor (in this case, 0.48).

Step 3: Calculating performance for specific EMS setting. Multiply the flow rate (8.2 gpm) obtained in Step 1 by the flow X Factor multiplier (0.58) in Step 2 to determine the flow rate at EMS setting 2. Multiply the air consumption (9.8 scfm) obtained in Step 1 by the air X Factor multiplier (0.48) in Step 2 to determine the air consumption at EMS setting 2 (Figure 3).

8.2 gpm	(flow rate for Setting 4)
.58	(Flow X Factor setting 2)
<hr/>	
4.8 gpm	(Flow rate for setting 2)
9.8 scfm	(air consumption for setting 4)
.48	(Air X Factor setting 2)
<hr/>	
4.7 scfm	(air consumption for setting 2)

Figure 3

The flow rate and air consumption at Setting 2 are found to be 18.2 lpm (4.8 gpm) and 7.9 Nm³/h (4.7 scfm) respectively.

Example 2.1

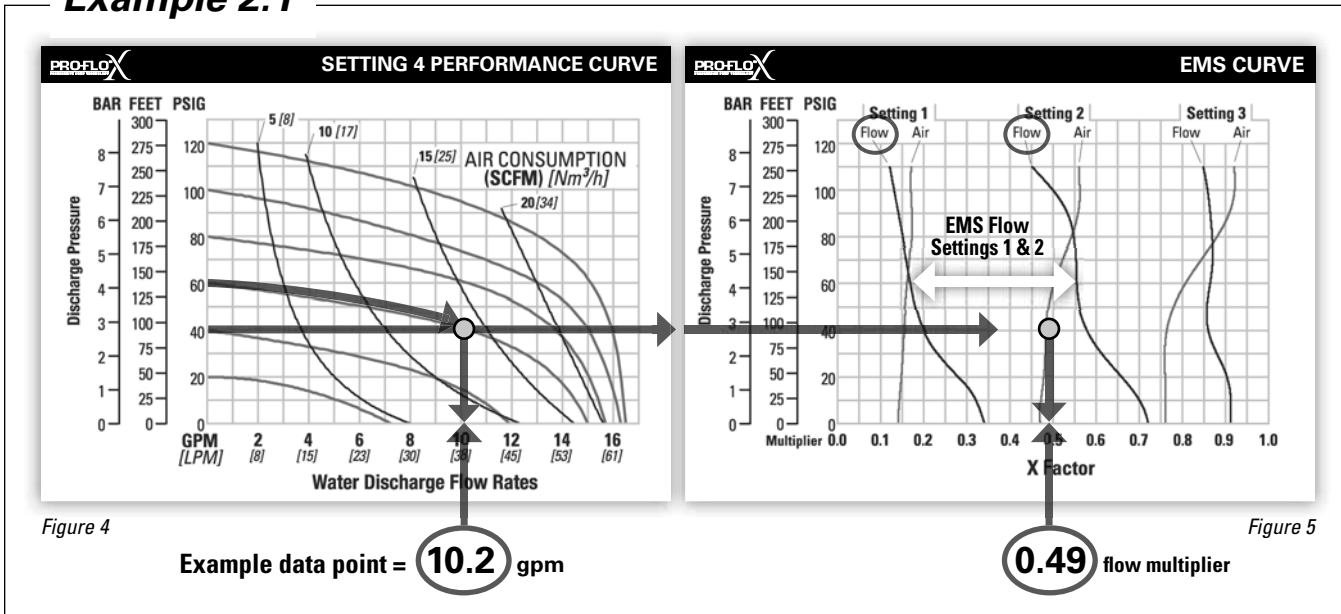

This is an example showing how to determine the inlet air pressure and the EMS setting for your Pro-Flo X™ pump to optimize the pump for a specific application. For this example we will be using an application requirement of 18.9 lpm (5 gpm) flow rate against 2.8 bar (40 psig) discharge pressure. This example will illustrate how to calculate the air consumption that could be expected at this operational point.

DETERMINE EMS SETTING

Step 1: Establish inlet air pressure. Higher air pressures will typically allow the pump to run more efficiently, however, available plant air pressure can vary greatly. If an operating pressure of 6.9 bar (100 psig) is chosen when plant air frequently dips to 6.2 bar (90 psig) pump performance will vary. Choose an operating pressure that is within your compressed air system's capabilities. For this example we will choose 4.1 bar (60 psig).

Step 2: Determine performance point at setting 4. For this example an inlet air pressure of 4.1 bar (60 psig) inlet air pressure has been chosen. Locate the curve that represents the performance of the pump with 4.1 bar (60 psig) inlet air pressure. Mark the point where this curve crosses the horizontal line representing 2.8 bar (40 psig) discharge pressure. After locating this point on the flow curve, draw a vertical line downward until reaching the bottom scale on the chart and identify the flow rate.

In our example it is 38.6 lpm (10.2 gpm). This is the setting 4 flow rate. Observe the location of the performance point relative to air consumption curves and approximate air consumption value. In our example setting 4 air consumption is 24 Nm³/h (14 scfm). See figure 4.

Step 3: Determine flow X Factor. Divide the required flow rate 18.9 lpm (5 gpm) by the setting 4 flow rate 38.6 lpm (10.2 gpm) to determine the flow X Factor for the application.

$$5 \text{ gpm} / 10.2 \text{ gpm} = 0.49 \text{ (flow X Factor)}$$

Step 4: Determine EMS setting from the flow X Factor. Plot the point representing the flow X Factor (0.49) and the application discharge pressure 2.8 bar (40 psig) on the EMS curve. This is done by following the horizontal 2.8 bar (40 psig) psig discharge pressure line until it crosses the vertical 0.49 X Factor line. Typically, this point lies between two flow EMS setting curves (in this case, the point lies between the flow curves for EMS setting 1 and 2). Observe the location of the point relative to the two curves it lies between and approximate the EMS setting (figure 5). For more precise results you can mathematically interpolate between the two curves to determine the optimal EMS setting.

For this example the EMS setting is 1.8.

Example 2.2

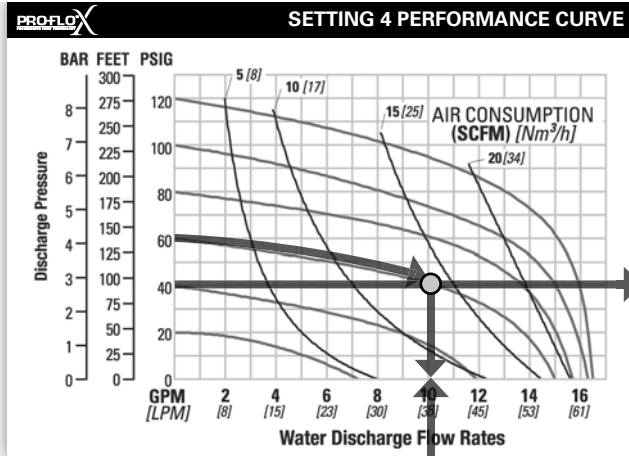

Figure 6

Example data point = **10.2** gpm

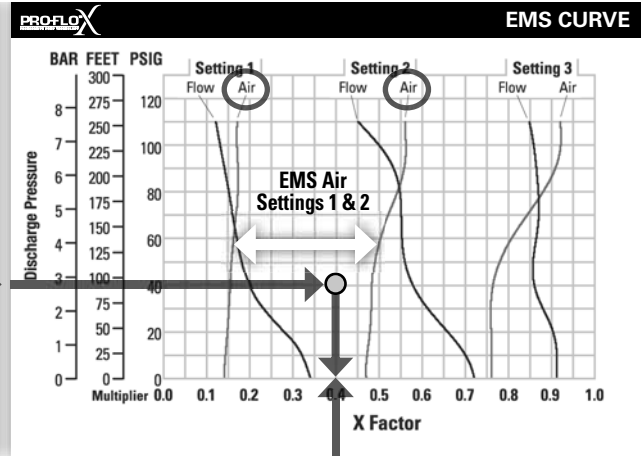

Figure 7

Example data point = **0.40** air multiplier

Determine air consumption at a specific EMS setting.

Step 1: Determine air X Factor. In order to determine the air X Factor, identify the two air EMS setting curves closest to the EMS setting established in example 2.1 (in this case, the point lies between the air curves for EMS setting 1 and 2). The point representing your EMS setting (1.8) must be approximated and plotted on the EMS curve along the horizontal line representing your discharge pressure (in this case, 40 psig). This air point is different than the flow point plotted in example 2.1. After estimating (or interpolating) this point on the curve, draw a vertical line downward until reaching the bottom scale on the chart and identify the air X Factor (figure 7).

For this example the air X Factor is **0.40**

Step 2: Determine air consumption. Multiply your setting 4 air consumption (14 scfm) value by the air X Factor obtained above (0.40) to determine your actual air consumption.

$$14 \text{ scfm} \times 0.40 = 5.6 \text{ SCFM}$$

In summary, for an application requiring 18.9 lpm (5 gpm) against 2.8 bar (40 psig) discharge pressure, the pump inlet air pressure should be set to 4.1 bar (60 psig) and the EMS dial should be set to 1.8. The pump would then consume 9.5 Nm³/h (5.6 scfm) of compressed air.

PX8 SANIFLO HS RUBBER-FITTED



PERFORMANCE



SETTING 4 PERFORMANCE CURVE

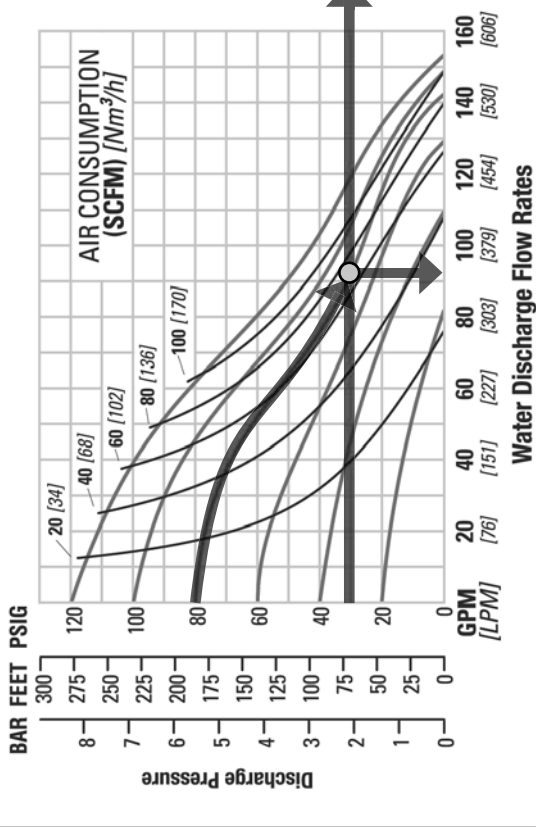

EMS CURVE

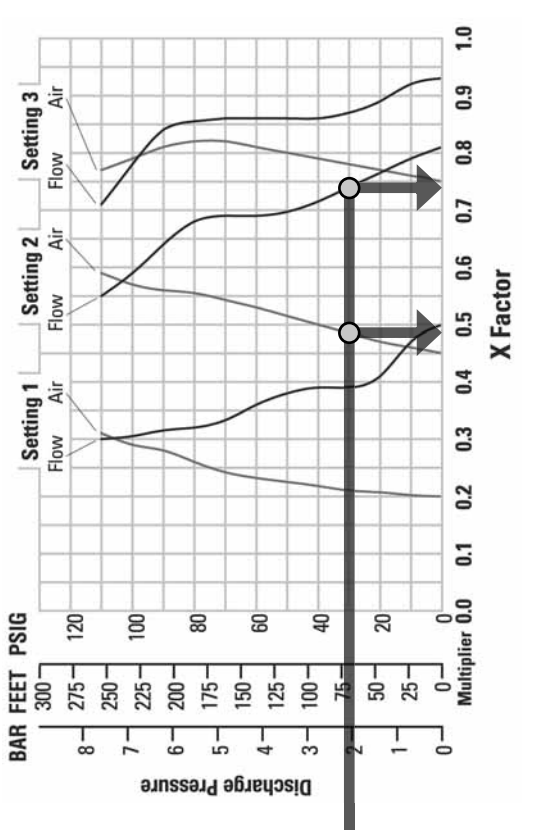

TECHNICAL DATA

Height	1008 mm (39.7")
Width	460 mm (18.1")
Depth	498 mm (19.6")
Ship Weight	49 kg (109 lbs.)
Air Inlet	19 mm (3/4")
Inlet	51 mm (2")
Outlet	51 mm (2")
Suction Lift	5.3 m Dry (17.3')
	9.0 m Wet (29.5')
Disp. Per Stroke	1.1 l (0.28 gal.)
Max. Flow Rate	579 lpm (153 gpm)
Max. Size Solids	6.4 mm (1/4")
Mushroom Valve	12.7 mm (1/2")
Ball Valve	47.5 mm (1-7/8")
Flap Valve (compressible solids)	47.5 mm (1-7/8")
Surface Finish	Ra 0.8 µm (32 µ-in)

¹Displacement per stroke was calculated at 4.8 bar (70 psig) air inlet pressure against a 2 bar (30 psig) head pressure.

Flow rates indicated on chart were determined by pumping water with a vertically mounted, center ported ball check configuration. When alternate check valve options are used, multiply flow rate by appropriate factor: Flap check valve = 83%. For optimum life and performance, pumps should be specified so that daily operation parameters fall in the center of the pump performance curve.

The Efficiency Management System (EMS) can be used to optimize the performance of your Wilden pump for specific applications. The pump is delivered with the EMS adjusted to setting 4, which allows maximum flow.

The EMS curve allows the pump user to determine flow and air consumption at each EMS setting. For any EMS setting and discharge pressure, the "X factor" is used as a multiplier with the original values from the setting 4 performance curve to calculate the actual flow and air consumption values for that specific EMS setting. Note: you can interpolate between the setting curves for operation at intermediate EMS settings

EXAMPLE

A PX8 Saniflo HS, Rubber-fitted pump operating at EMS setting 4, achieved a flow rate of 348 lpm (92 gpm) using 119 Nm³/h (70 scfm) of air when run at 5.5 bar (80 psig) air inlet pressure and 2.1 bar (30 psig) discharge pressure (See dot on performance curve).

The end user did not require that much flow and wanted to reduce air consumption at his facility. He determined that EMS setting 2 would meet his needs. At 2.1 bar (30 psig) discharge pressure and EMS setting 2, the flow "X factor" is 0.74 and the air "X factor" is 0.48 (see dots on EMS curve).

Multiplying the original setting 4 values by the "X factors" provides the setting 2 flow rate of 258 lpm (68 gpm) and an air consumption of 57 Nm³/h (34 scfm). The flow rate was reduced by 26% while the air consumption was reduced by 52%, thus providing increased efficiency.

For a detailed example for how to set your EMS, see beginning of performance curve section.

Caution: Do not exceed 8.6 bar (125 psig) air supply pressure.

PX8 SANIFLO HS TPE-FITTED

SETTING 4 PERFORMANCE CURVE

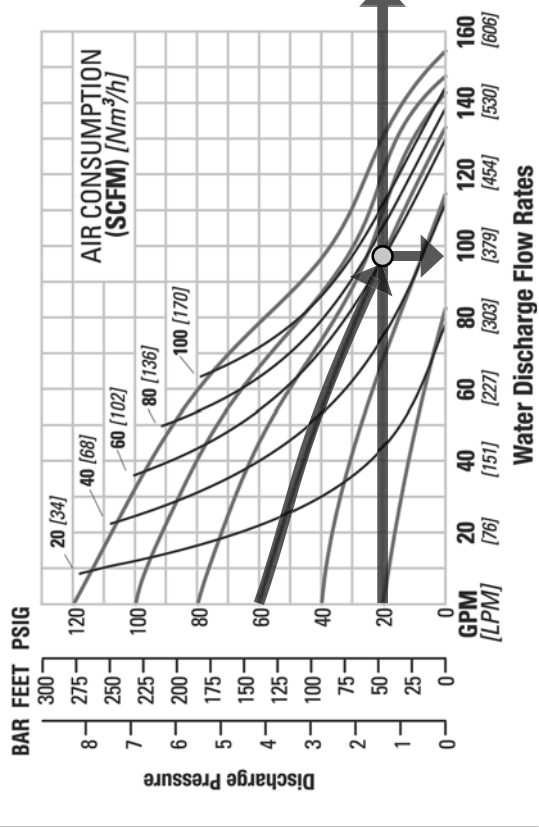

EMS CURVE

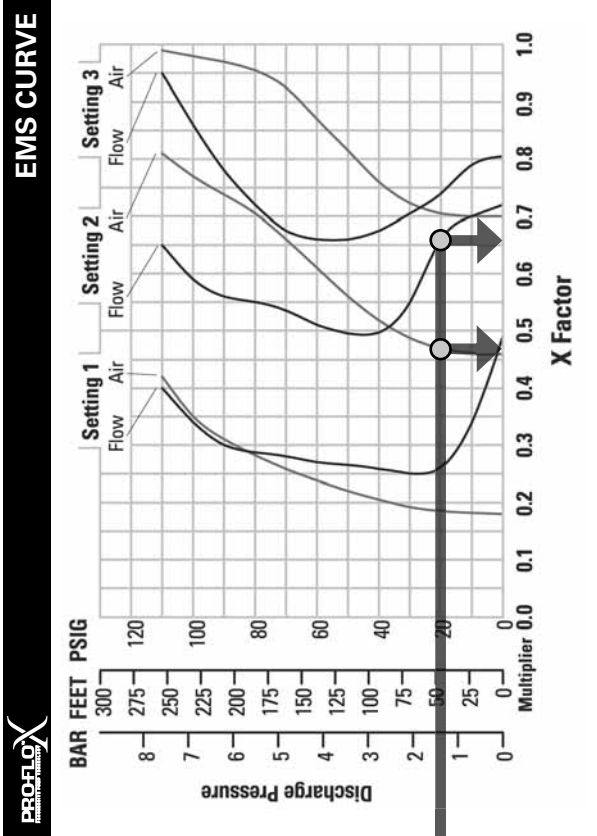

TECHNICAL DATA

Height	1008 mm (39.7")
Width	460 mm (18.1")
Depth	498 mm (19.6")
Ship Weight	49 kg (109 lbs.)
Air Inlet	19 mm (3/4")
Inlet	51 mm (2")
Outlet	51 mm (2")
Suction Lift	1.9 m Dry (6.2')
	9.0 m Wet (29.5')
Disp. Per Stroke	1.2 l (0.33 gal.)
Max. Flow Rate	587 lpm (155 gpm)
Max. Size Solids	6.4 mm (1/4")
Mushroom Valve	12.7 mm (1/2")
Ball Valve	47.5 mm (1-7/8")
Flap Valve (compressible solids)	47.5 mm (1-7/8")
Surface Finish	Ra 0.8 µm (32 µ-in)

¹Displacement per stroke was calculated at 4.8 bar (70 psig) air inlet pressure against a 2 bar (30 psig) head pressure.

Flow rates indicated on chart were determined by pumping water with a vertically mounted, center ported ball check configuration. When alternate check valve options are used, multiply flow rate by appropriate factor: Flap check valve = 83%. For optimum life and performance, pumps should be specified so that daily operation parameters fall in the center of the pump performance curve.

The Efficiency Management System (EMS) can be used to optimize the performance of your Wilden pump for specific applications. The pump is delivered with the EMS adjusted to setting 4, which allows maximum flow.

The EMS curve allows the pump user to determine flow and air consumption at each EMS setting. For any EMS setting and discharge pressure, the "X factor" is used as a multiplier with the original values from the setting 4 performance curve to calculate the actual flow and air consumption values for that specific EMS setting. Note: you can interpolate between the setting curves for operation at intermediate EMS settings.

EXAMPLE

A PX8 Saniflo HS, TPE-fitted pump operating at EMS setting 4, achieved a flow rate of 367 lpm (97 gpm) using 102 Nm³/h (60 scfm) of air when run at 4.1 bar (60 psig) air inlet pressure and 1.4 bar (20 psig) discharge pressure (See dot on performance curve).

The end user did not require that much flow and wanted to reduce air consumption at his facility. He determined that EMS setting 2 would meet his needs. At 1.4 bar (20 psig) discharge pressure and EMS setting 2, the flow "X factor" is 0.66 and the air "X factor" is 0.47 (see dots on EMS curve).

Multiplying the original setting 4 values by the "X factors" provides the setting 2 flow rate of 242 lpm (64 gpm) and an air consumption of 48 Nm³/h (28 scfm). The flow rate was reduced by 34% while the air consumption was reduced by 53%, thus providing increased efficiency.

For a detailed example for how to set your EMS, see beginning of performance curve section.

Caution: Do not exceed 8.6 bar (125 psig) air supply pressure.

PX8 SANIFLO HS PTFE-FITTED



PERFORMANCE



SETTING 4 PERFORMANCE CURVE

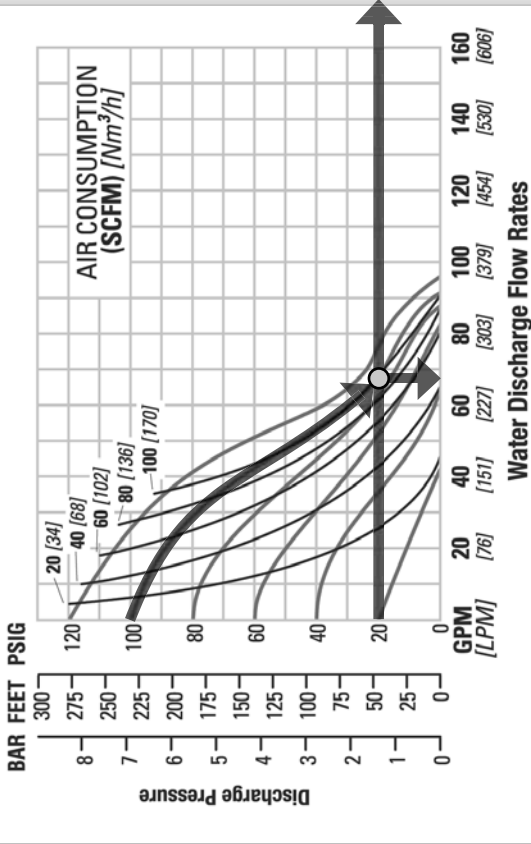

EMS CURVE

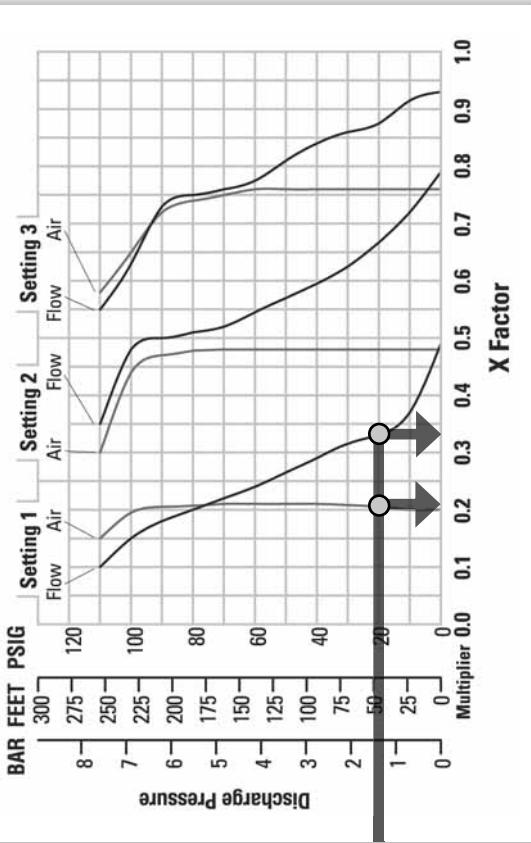

TECHNICAL DATA

Height	1008 mm (39.7")
Width	460 mm (18.1")
Depth	498 mm (19.6")
Ship Weight	49 kg (109 lbs.)
Air Inlet	19 mm (3/4")
Inlet	51 mm (2")
Outlet	51 mm (2")
Suction Lift	2.8 m Dry (9.1')
	9.0 m Wet (29.5')
Disp. Per Stroke	0.5 l (0.13 gal.)
Max. Flow Rate	353 lpm (96 gpm)
Max. Size Solids	
Mushroom Valve	6.4 mm (1/4")
Ball Valve	12.7 mm (1/2")
Surface Finish	Ra 0.8 µm (32 µ-in)

¹Displacement per stroke was calculated at 4.8 bar (70 psig) air inlet pressure against a 2 bar (30 psig) head pressure.

Flow rates indicated on chart were determined by pumping water with a vertically mounted, center ported ball check configuration. When alternate check valve options are used, multiply flow rate by appropriate factor. For optimum life and performance, pumps should be specified so that daily operation parameters fall in the center of the pump performance curve.

The Efficiency Management System (EMS) can be used to optimize the performance of your Wilden pump for specific applications. The pump is delivered with the EMS adjusted to setting 4, which allows maximum flow.

The EMS curve allows the pump user to determine flow and air consumption at each EMS setting. For any EMS setting and discharge pressure, the "X factor" is used as a multiplier with the original values from the setting 4 performance curve to calculate the actual flow and air consumption values for that specific EMS setting. Note: you can interpolate between the setting curves for operation at intermediate EMS settings.

EXAMPLE

A PX8 Saniflo HS, PTFE-fitted pump operating at EMS setting 4, achieved a flow rate of 257 lpm (68 gpm) using 170 Nm³/h (100 scfm) of air when run at 6.9 bar (100 psig) air inlet pressure and 1.4 bar (20 psig) discharge pressure (See dot on performance curve).

The end user did not require that much flow and wanted to reduce air consumption at his facility. He determined that EMS setting 1 would meet his needs. At 1.4 bar (20 psig) discharge pressure and EMS setting 1, the flow "X factor" is 0.33 and the air "X factor" is 0.21 (see dots on EMS curve).

Multiplying the original setting 4 values by the "X factors" provides the setting 1 flow rate of 85 lpm (22 gpm) and an air consumption of 36 Nm³/h (21 scfm). The flow rate was reduced by 67% while the air consumption was reduced by 79%, thus providing increased efficiency.

For a detailed example for how to set your EMS, see beginning of performance curve section.

Caution: Do not exceed 8.6 bar (125 psig) air supply pressure.

PX8 SANIFLO HS ULTRA-FLEX™-FITTED

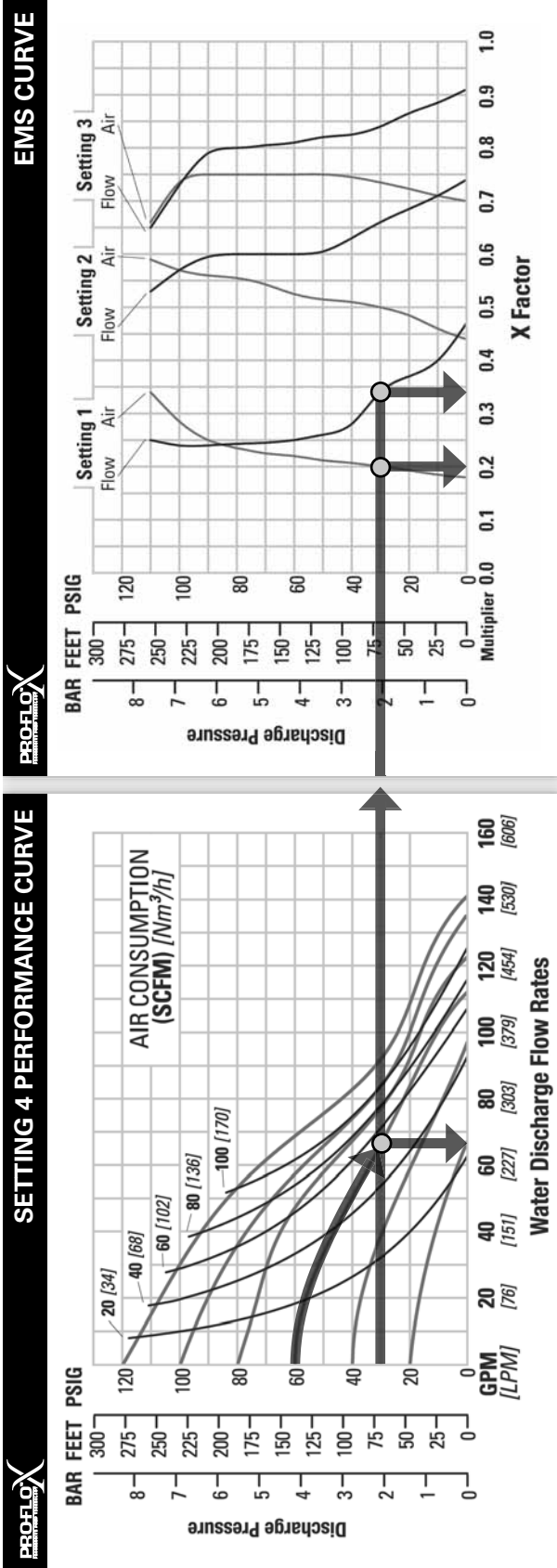

TECHNICAL DATA

Height	1008 mm (39.7")
Width	460 mm (18.1")
Depth	498 mm (19.6")
Ship Weight	49 kg (109 lbs.)
Air Inlet	19 mm (3/4")
Inlet	51 mm (2")
Outlet	51 mm (2")
Suction Lift	3.8 m Dry (12.5')
	9.0 m Wet (29.5')
Disp. Per Stroke	0.9 l (0.23 gal.)
Max. Flow Rate	.534 lpm (141 gpm)
Max. Size Solids	.64 mm (1/4")
Mushroom Valve	12.7 mm (1/2")
Ball Valve	Ra 0.8 µm (32 µ-in)

¹Displacement per stroke was calculated at 4.8 bar (70 psig) air inlet pressure against a 2 bar (30 psig) head pressure.

Flow rates indicated on chart were determined by pumping water with a vertically mounted, center ported ball check configuration. When alternate check valve options are used, multiply flow rate by appropriate factor. For optimum life and performance, pumps should be specified so that daily operation parameters fall in the center of the pump performance curve.

EXAMPLE

A PX8 Saniflo HS, Ultra-Flex-fitted pump operating at EMS setting 4, achieved a flow rate of 250 lpm (66 gpm) using 97 Nm³/h (57 scfm) of air when run at 4.1 bar (60 psig) air inlet pressure and 2.1 bar (30 psig) discharge pressure (See dot on performance curve).

The end user did not require that much flow and wanted to reduce air consumption at his facility. He determined that EMS setting 1 would meet his needs. At 2.1 bar (30 psig) discharge pressure and EMS setting 1, the flow "X factor" is 0.34 and the air "X factor" is 0.20 (see dots on EMS curve).

Multiplying the original setting 4 values by the "X factors" provides the setting 1 flow rate of 85 lpm (22 gpm) and an air consumption of 19 Nm³/h (11 scfm). The flow rate was reduced by 66% while the air consumption was reduced by 80%, thus providing increased efficiency.

For a detailed example for how to set your EMS, see beginning of performance curve section.

Caution: Do not exceed 8.6 bar (125 psig) air supply pressure.

PX8 SANIFLO HS SIPD-FITTED (Sanitary Integrate Piston Diaphragm)

SETTING 4 PERFORMANCE CURVE

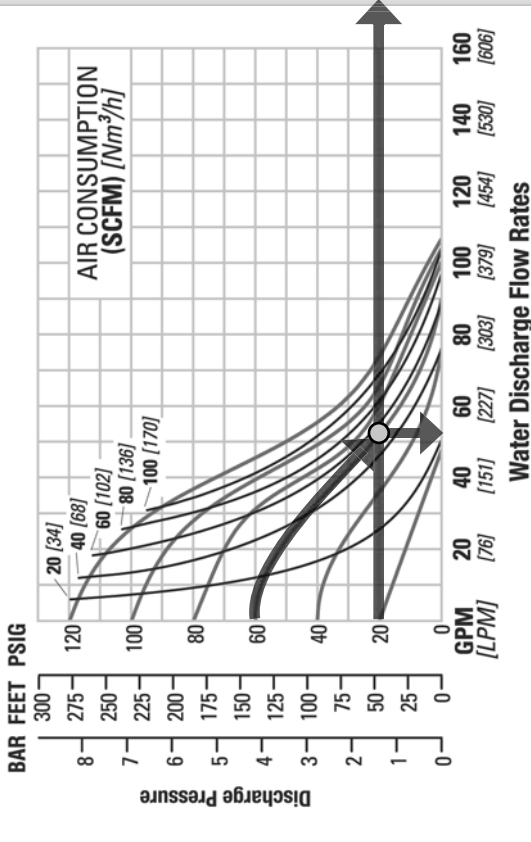

EMS CURVE

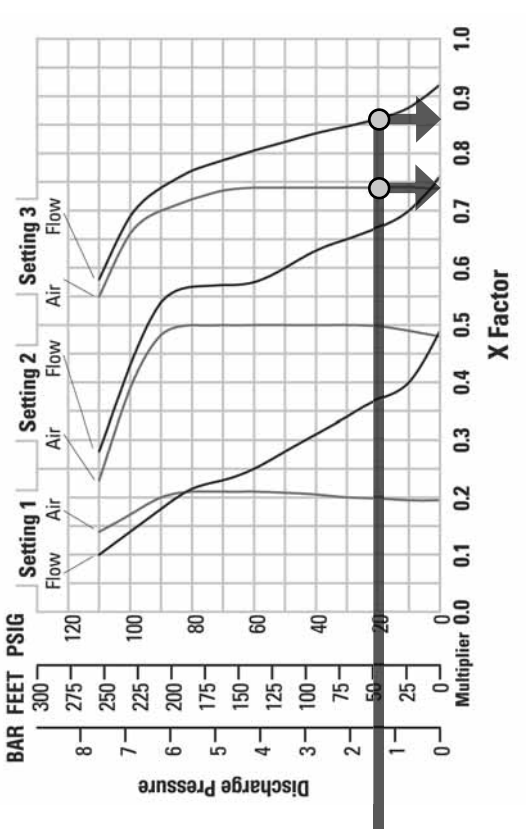

TECHNICAL DATA

Height.....	1008 mm (39.7")
Width.....	460 mm (18.1")
Depth.....	498 mm (19.6")
Ship Weight.....	49 kg (109 lbs.)
Air Inlet.....	19 mm (3/4")
Inlet.....	51 mm (2")
Outlet.....	51 mm (2")
Suction Lift.....	2.3 m Dry (7.4')
.....	9.0 m Wet (29.5')
Disp. Per Stroke.....	0.4 l (0.11 gal.) ¹
Max. Flow Rate.....	405 lpm (107 gpm)
Max. Size Solids.....
Mushroom Valve.....	6.4 mm (1/4")
Ball Valve.....	12.7 mm (1/2")
Surface Finish.....	Ra 0.8 µm (32 µ-in)

¹Displacement per stroke was calculated at 4.8 bar (70 psig) air inlet pressure against a 2 bar (30 psig) head pressure.

Flow rates indicated on chart were determined by pumping water with a vertically mounted, center ported ball check configuration. When alternate check valve options are used, multiply flow rate by appropriate factor. For optimum life and performance, pumps should be specified so that daily operation parameters fall in the center of the pump performance curve.

The Efficiency Management System (EMS) can be used to optimize the performance of your Wilden pump for specific applications. The pump is delivered with the EMS adjusted to setting 4, which allows maximum flow.

The EMS curve allows the pump user to determine flow and air consumption at each EMS setting. For any EMS setting and discharge pressure, the "X factor" is used as a multiplier with the original values from the setting 4 performance curve to calculate the actual flow and air consumption values for that specific EMS setting. Note: you can interpolate between the setting curves for operation at intermediate EMS settings.

EXAMPLE

A PX8 Saniflo HS, SIPD-fitted pump operating at EMS setting 4, achieved a flow rate of 197 lpm (52 gpm) using 93 Nm³/h (55 scfm) of air when run at 4.1 bar (60 psig) air inlet pressure and 1.4 bar (20 psig) discharge pressure (See dot on performance curve).

The end user did not require that much flow and wanted to reduce air consumption at his facility. He determined that EMS setting 3 would meet his needs. At 1.4 bar (20 psig) discharge pressure and EMS setting 3, the flow "X factor" is 0.87 and the air "X factor" is 0.74 (see dots on EMS curve).

Multiplying the original setting 4 values by the "X factors" provides the setting 3 flow rate of 171 lpm (45 gpm) and an air consumption of 69 Nm³/h (41 scfm). The flow rate was reduced by 13% while the air consumption was reduced by 26%, thus providing increased efficiency.

For a detailed example for how to set your EMS, see beginning of performance curve section.

Caution: Do not exceed 8.6 bar (125 psig) air supply pressure.



SUCTION LIFT CURVES

**PX8 SANIFLO™ HS
SUCTION LIFT CAPABILITY**

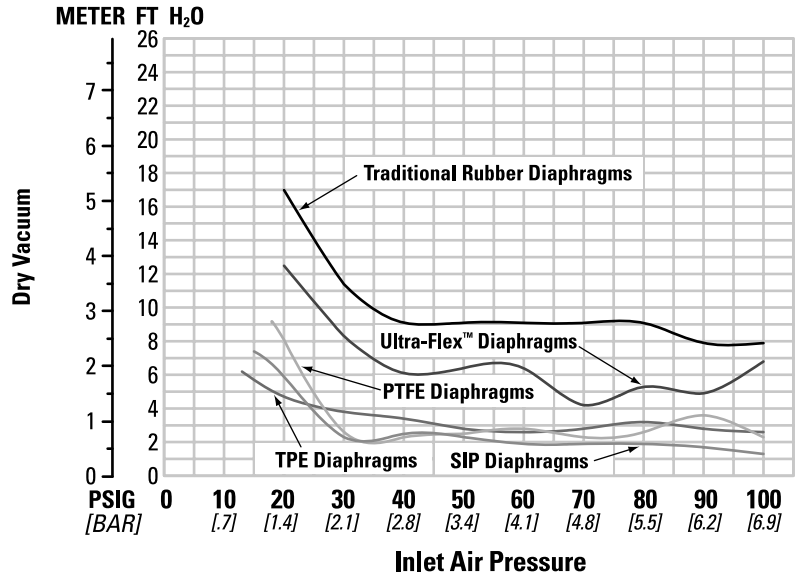

Suction lift curves are calibrated for pumps operating at 305 m (1,000') above sea level. This chart is meant to be a guide only. There are many variables which can affect your pump's operating characteristics. The

number of intake and discharge elbows, viscosity of pumping fluid, elevation (atmospheric pressure) and pipe friction loss all affect the amount of suction lift your pump will attain.

THE RULES HAVE CHANGED.

X

Take control of your process today with

PROFLO™
PROGRESSIVE PUMP TECHNOLOGY X

WILDEN®
A DOVER COMPANY

22069 Van Buren St. • Grand Terrace, CA 92313-5651
Tel 909-422-1730 • Fax 909-783-3440 • www.wildenx.com

SUGGESTED INSTALLATION

Wilden pumps are designed to meet the performance requirements of even the most demanding pumping applications. They have been designed and manufactured to the highest standards and are available in a variety of liquid path materials to meet your chemical resistance needs. Refer to the performance section of this manual for an in-depth analysis of the performance characteristics of your pump. Wilden offers the widest variety of elastomer options in the industry to satisfy temperature, chemical compatibility, abrasion resistance and flex concerns.

The suction pipe size should be equivalent or larger than the diameter of the suction inlet on your Wilden pump. The suction hose must be non-collapsible, reinforced type as these pumps are capable of pulling a high vacuum. Discharge piping should also be equivalent or larger than the diameter of the pump discharge to minimize friction losses. It is critical that all fittings and connections are airtight or a reduction or loss of pump suction capability will result.

INSTALLATION: Months of careful planning, study, and selection efforts can result in unsatisfactory pump performance if installation details are left to chance.

Premature failure and long term dissatisfaction can be avoided if reasonable care is exercised throughout the installation process.

LOCATION: Noise, safety, and other logistical factors usually dictate where equipment will be situated on the production floor. Multiple installations with conflicting requirements can result in congestion of utility areas, leaving few choices for additional pumps.

Within the framework of these and other existing conditions, every pump should be located in such a way that six key factors are balanced against each other to maximum advantage.

ACCESS: First of all, the location should be accessible. If it's easy to reach the pump, maintenance personnel will have an easier time carrying out routine inspections and adjustments. Should major repairs become necessary, ease of access can play a key role in speeding the repair process and reducing total downtime.

AIR SUPPLY: Every pump location should have an air line large enough to supply the volume of air necessary to achieve the desired pumping rate. Do not exceed the maximum rated air pressure.

For best results, the pumps should use a 5 μ (micron) air filter, needle valve and regulator. The use of an air filter before the pump will ensure that the majority of any pipeline contaminants will be eliminated.

SOLENOID OPERATION: When operation is controlled by a solenoid valve in the air line, three-way valves should be used. This valve allows trapped air between the valve and the pump to bleed off which improves pump performance.

MUFFLER: Sound levels are reduced below OSHA specifications using the standard Wilden muffler. Other mufflers can be used to further reduce sound levels, but they usually reduce pump performance.

ELEVATION: Selecting a site that is well within the pump's dynamic lift capability will assure that loss-of-prime issues will be eliminated. In addition, pump efficiency can be adversely affected if proper attention is not given to site location.

PIPING: Final determination of the pump site should not be made until the piping challenges of each possible location have been evaluated. The impact of current and future installations should be considered ahead of time to make sure that inadvertent restrictions are not created for any remaining sites.

The best choice possible will be a site involving the shortest and straightest hook-up of suction and discharge piping. Unnecessary elbows, bends, and fittings should be avoided. Pipe sizes should be selected to keep friction losses within practical limits. All piping should be supported independently of the pump. In addition, the piping should be aligned to avoid placing stress on the pump fittings.

Flexible hose can be installed to aid in absorbing the forces created by the natural reciprocating action of the pump. If the pump is to be bolted down to a solid location, a mounting pad placed between the pump and the foundation will assist in minimizing pump vibration. Flexible connections between the pump and rigid piping will also assist in minimizing pump vibration. If quick-closing valves are installed at any point in the discharge system, or if pulsation within a system becomes a problem, a surge suppressor (SD Equalizer[®]) should be installed to protect the pump, piping and gauges from surges and water hammer.

If the pump is to be used in a self-priming application, make sure that all connections are airtight and that the suction lift is within the model's ability. Note: Materials of construction and elastomer material have an effect on suction lift parameters. Please refer to the performance section for specifics.

When pumps are installed in applications involving flooded suction or suction head pressures, a gate valve should be installed in the suction line to permit closing of the line for pump service.

Pumps in service with a positive suction head are most efficient when inlet pressure is limited to 0.5–0.7 bar (7–10 psig). Premature diaphragm failure may occur if positive suction is 0.7 bar (10 psig) and higher.

SUBMERSIBLE APPLICATIONS: Pro-Flo V[™] and Pro-Flo X[™] pumps can be used for submersible applications, when using the Pro-Flo V[™] or Pro-Flo X[™] submersible option. Turbo-Flo[™] pumps can also be used for submersible applications. Pro-Flo[®] and Accu-Flo[™] pumps are not submersible.

ALL WILDEN PUMPS ARE CAPABLE OF PASSING SOLIDS. A STRAINER SHOULD BE USED ON THE PUMP INTAKE TO ENSURE THAT THE PUMP'S RATED SOLIDS CAPACITY IS NOT EXCEEDED.

SUGGESTED INSTALLATION

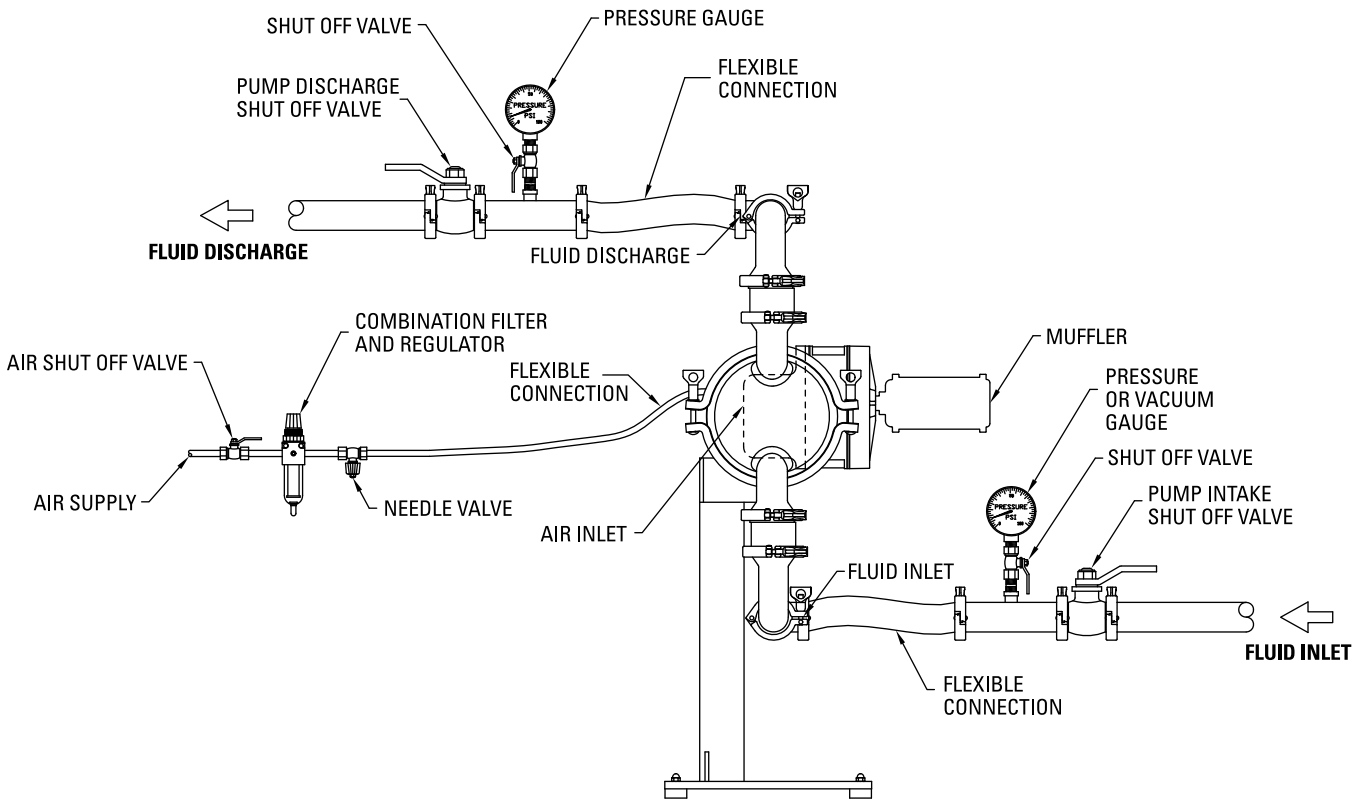

NOTE: In the event of a power failure, the air shut off valve should be closed, if restarting of the pump is not desirable once power is regained.

AIR OPERATED PUMPS: To stop the pump from operating in an emergency situation, simply close the air shut off valve (user supplied) installed in the air supply line. A properly functioning

valve will stop the air supply to the pump, therefore stopping output. This air shut off valve should be located far enough away from the pumping equipment such that it can be reached safely in an emergency situation.

SUGGESTED OPERATION & MAINTENANCE

OPERATION: The Pro-Flo® and Pro-Flo X™ pumps are pre-lubricated, and do not require in-line lubrication. Additional lubrication will not damage the pump, however if the pump is heavily lubricated by an external source, the pump's internal lubrication may be washed away. If the pump is then moved to a non-lubricated location, it may need to be disassembled and re-lubricated as described in the ASSEMBLY/DISASSEMBLY INSTRUCTIONS.

Pump discharge rate can be controlled by limiting the volume and/or pressure of the air supply to the pump. An air regulator is used to regulate air pressure. A needle valve is used to regulate volume. Pump discharge rate can also be controlled by throttling the pump discharge by partially closing a valve in the discharge line of the pump. This action increases friction loss which reduces flow rate. (See Section 5.) This is useful when the need exists to control the pump from a remote location. When the pump discharge pressure equals or exceeds the air supply pressure, the pump will stop; no bypass or pressure relief valve is needed, and pump damage will not occur. The pump has reached a "deadhead" situation and can be restarted by reducing the fluid

discharge pressure or increasing the air inlet pressure. The Wilden Pro-Flo® and Pro-Flo X™ pumps run solely on compressed air and do not generate heat, therefore your process fluid temperature will not be affected.

MAINTENANCE AND INSPECTIONS: Since each application is unique, maintenance schedules may be different for every pump. Frequency of use, line pressure, viscosity and abrasiveness of process fluid all affect the parts life of a Wilden pump. Periodic inspections have been found to offer the best means for preventing unscheduled pump downtime. Personnel familiar with the pump's construction and service should be informed of any abnormalities that are detected during operation.

RECORDS: When service is required, a record should be made of all necessary repairs and replacements. Over a period of time, such records can become a valuable tool for predicting and preventing future maintenance problems and unscheduled downtime. In addition, accurate records make it possible to identify pumps that are poorly suited to their applications.

TROUBLESHOOTING

Pump will not run or runs slowly.

1. Ensure that the air inlet pressure is at least 0.4 bar (5 psig) above startup pressure and that the differential pressure (the difference between air inlet and liquid discharge pressures) is not less than 0.7 bar (10 psig).
2. Check air inlet filter for debris (see recommended installation).
3. Check for extreme air leakage (blow by) which would indicate worn seals/bore in the air valve, pilot spool, main shaft.
4. Disassemble pump and check for obstructions in the air passageways or objects which would obstruct the movement of internal parts.
5. Check mating surfaces of flap valve assembly.
6. Check for sticking ball check valves. If material being pumped is not compatible with pump elastomers, swelling may occur. Replace ball check valves and seats with proper elastomers. Also, as the check valve balls wear out, they become smaller and can become stuck in the seats. In this case, replace balls and seats.
7. Check for broken inner piston which will cause the air valve spool to be unable to shift.
8. Remove plug from pilot spool exhaust.

Pump runs but little or no product flows.

1. Check for pump cavitation; slow pump speed down to allow thick material to flow into liquid chambers.

2. Verify that vacuum required to lift liquid is not greater than the vapor pressure of the material being pumped (cavitation).
3. Check for sticking ball check valves. If material being pumped is not compatible with pump elastomers, swelling may occur. Replace ball check valves and seats with proper elastomers. Also, as the check valve balls wear out, they become smaller and can become stuck in the seats. In this case, replace balls and seats.

Pump air valve freezes.

1. Check for excessive moisture in compressed air. Either install a dryer or hot air generator for compressed air. Alternatively, a coalescing filter may be used to remove the water from the compressed air in some applications.

Air bubbles in pump discharge.

1. Check for ruptured diaphragm.
2. Check tightness of outer pistons (refer to Section 7).
3. Check tightness of fasteners and integrity of o-rings and seals, especially at intake manifold.
4. Ensure pipe connections are airtight.

Product comes out air exhaust.

1. Check for diaphragm rupture.
2. Check tightness of outer pistons to shaft.



PUMP DISASSEMBLY

Tools Required:

- Adjustable Wrench
- Vise equipped with soft jaws (such as plywood, plastic or other suitable material)

CAUTION: Before any maintenance or repair is attempted, the compressed air line to the pump should be disconnected and all air pressure allowed to bleed from the pump. Disconnect all intake, discharge, and air lines. Drain the pump by turning it upside down and allowing any fluid to flow into a suitable container. Be aware of any hazardous effects of contact with your process fluid.

NOTE: The model photographed for these instructions incorporates PTFE diaphragms.

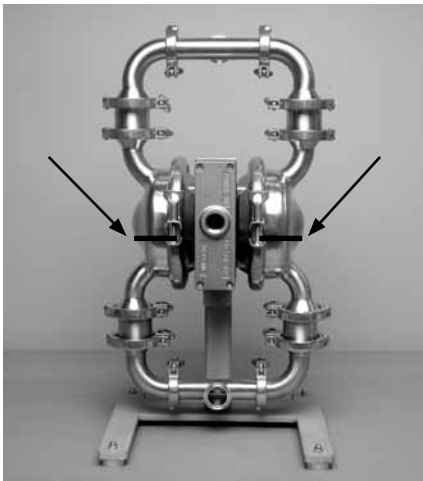

Step 1

Prior to assembly, alignment marks should be placed on the liquid chambers and air chambers to assist with proper alignment during reassembly.



Step 2

Loosen the wing nut and remove both discharge manifold clamp bands.

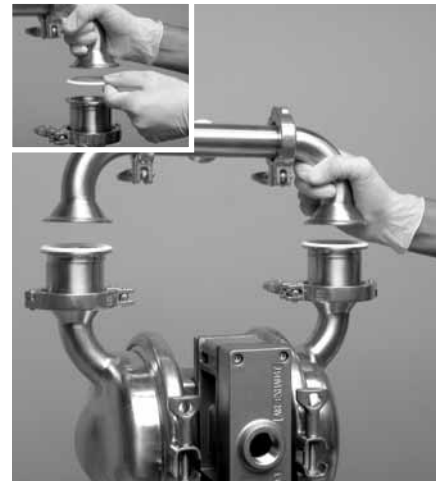

Step 3

Remove the discharge manifold and manifold gaskets.



Step 4

Next, remove the clamp bands that secure the ball valve housing to the liquid chamber.



Step 5A

Next, remove the ball valve housing, valve ball and gasket.



Step 5B

If your pump is fitted with a mushroom valve, remove the mushroom valve housing, mushroom valve and gasket.



Step 6

Loosen the wing nut and remove the inlet manifold clamp bands.



Step 7

Next, remove the clamp bands that secure the ball valve housing to the liquid chamber.



Step 8

Next, remove the ball valve housing, valve ball and gasket from liquid chamber. To ensure proper alignment during reassembly of manifold/liquid chamber interface, turn off-set portion of valve housing to the left or to the right. This procedure works for the inlet manifold and discharge manifold connections.

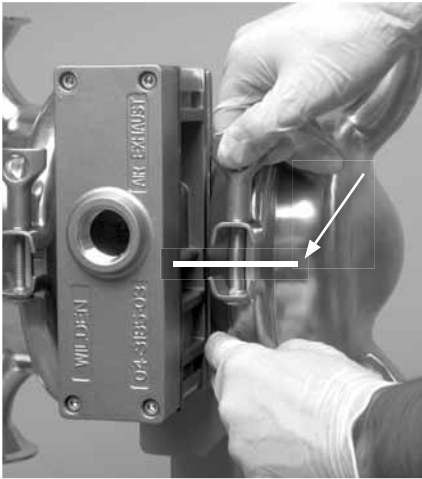

Step 9

Now the large clamp bands can be removed. NOTE: Prior to assembly, alignment marks should be placed on the liquid chambers and air chambers to assist with proper alignment during reassembly.



Step 10A

Next, remove the liquid chamber from the center section assembly.



Step 10B

If your pump is fitted with an integral piston diaphragm (IPD), when you remove the liquid chamber you will notice that there is no outer piston.



Step 11A

Using two adjustable wrenches, turning in the opposite direction, loosen and remove one of the two outer pistons.



Step 11B

If your pump is fitted with an IPD, the procedure for removing the diaphragm is slightly different. In this case, simply grasp the diaphragm in two locations and turn in a counter-clockwise direction.



Step 12A

After loosening and removing the outer piston, the remaining diaphragm assembly and shaft can be removed from the center section assembly.



Step 12B

If your pump is fitted with an IPD, the procedure for removing the diaphragm is the same.

WIL-GARD™ DIAPHRAGM SENSOR

Wil-Gard™ Diaphragm Sensor Removal



Step 1

After removing the inlet and discharge manifold assemblies, disconnect the Wil-Gard™ module from the sensor wires.



Step 2

Next, remove the large clamp bands and the liquid chamber on either side of the pump.



Step 3

The Wil-Gard™ sensor cables can be easily removed from the diaphragm assembly by simply pulling them from between the primary and back-up diaphragm.

WIL-GARD[™] DIAPHRAGM SENSOR

Wil-Gard[™] Diaphragm Sensor Installation



Step 1

The Wil-Gard[™] sensor wires must be installed between the primary diaphragm and the back-up diaphragm, on both sides of the pump, at the 6 o'clock position. They should be positioned approximately half the distance to the shaft from the edge of the diaphragm.



Step 2

Prior to installing the liquid chamber, and after positioning the Wil-Gard[™] sensor cable between the primary and back-up diaphragms, run the sensor cable along the diaphragm bead but outside the pump. Now install the liquid chamber and large clamp band.



Step 3

When installing the liquid chamber and large clamp band, route the Wil-Gard[™] sensor cable to the inside of the large clamp band fastener. Next, reconnect the Wil-Gard[™] module. **NOTE:** Use caution to ensure that the sensor wires are not damaged or pinched by the clamp band.

AIR VALVE / CENTER SECTION DISASSEMBLY

Tools Required:

Tools Required:

- 3/16" Hex Head Wrench
- 1/4" Hex Head Wrench
- Snap Ring Pliers
- O-Ring Pick

CAUTION: Before any maintenance or repair is attempted, the compressed air line to the pump should be disconnected and all air pressure allowed to bleed from the pump. Disconnect all intake, discharge, and air lines. Drain the pump by turning it upside down and allowing any fluid to flow into a suitable container. Be aware of hazardous effects of contact with your process fluid.



Step 1

Using a 9/16" wrench, loosen the bolts that connect the center section to the stand. **CAUTION:** With bolts removed, the center section is no longer attached to the stand and must be supported so that it does not fall from the stand.



Step 2

Remove the center section from the stand.



Step 3

Using a 3/16" hex wrench, loosen air valve bolts.

AIR VALVE / CENTER SECTION DISASSEMBLY

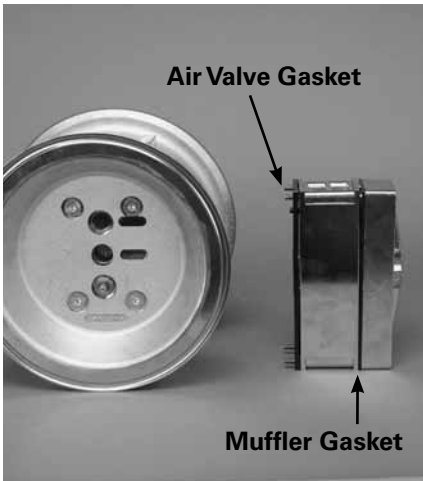

Step 4

Remove muffer plate and air valve bolts from air valve assembly exposing muffer gasket for inspection. Replace if necessary.

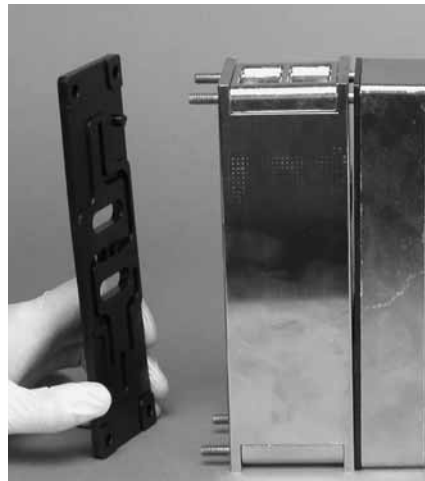

Step 5

Lift away air valve assembly and remove air valve gasket for inspection. Replace if necessary.



Step 6

Remove air valve end cap to expose air valve spool by simply lifting up on end cap once air valve bolts are removed. Note: Pro-Flo V™ air valve incorporates an end cap at both ends of the air valve.



Step 7

Remove the air valve spool from the air valve body by threading one air valve bolt into the end of the air valve spool and gently sliding the spool out of the air valve body. Inspect seals for signs of wear and replace entire assembly if necessary. Use caution when handling air valve spool to prevent damaging seals. Note: seals should not be removed from assembly. Seals are not sold separately.



Step 8

Remove pilot sleeve retaining snap ring on both sides of center section with snap ring pliers.



Step 9

Remove pilot spool sleeve from center section.

AIR VALVE / CENTER SECTION DISASSEMBLY

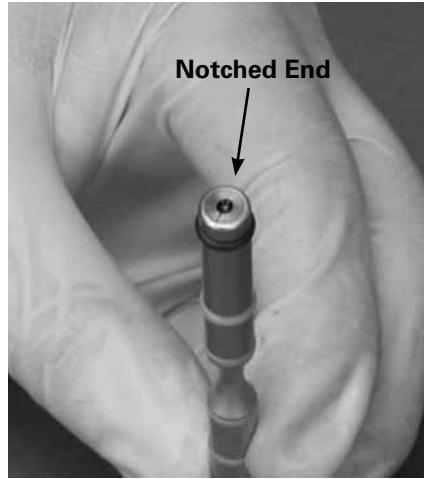

Step 10

Using an o-ring pick, gently remove the o-ring from the opposite side of the “notched end” on one side of the pilot spool. Gently remove the pilot spool from pilot spool sleeve and inspect for nicks, gouges and wear. Replace pilot sleeve or outer sleeve o-rings if necessary. During re-assembly, never insert the pilot spool into the sleeve with the “notched end” first, this end incorporates the urethane o-ring and will be damaged as it slides over the ports cut in the sleeve. Note: seals should not be removed from pilot spool. Seals are not sold separately.

Finding spares a nightmare? Sleep easier with **SPECTROM**



PRODUCTS: AODDP
(Air Operated Double Diaphragm Pumps)

- Warren-Rupp
- ARO
- Other



PUMP PARTS
(Low Cost)

- Diaphragms
- Valve balls
- Valve seats



KNOWLEDGE & SERVICE

- Competitive pricing
- Delivery
- Service
- Inventory

Spectrom is not your typical after market part supplier. We do not simply sell pump parts; we provide value added procurement solutions.

Our unique network enables us to purchase effectively, resulting in low cost solutions. We also know that low purchase price is not enough - quality, integrity and inventory are also important. Spectrom is structured to provide Pre and Post sales support, giving our customers value added application and pump knowledge.

Contact us to have a procurement solution developed for you. We don't just fit you into a generic system, we develop specific solutions that achieve results.

Spectrom will ship your order from our facility within 3 working days!



WARNING: These parts may exhibit better life than OEM parts.

1-909-512-1261

www.spectromparts.com

ASSEMBLY:

Upon performing applicable maintenance to the air distribution system, the pump can now be reassembled. Please refer to the disassembly instructions for photos and parts placement. To reassemble the pump, follow the disassembly instructions in reverse order. The air distribution system needs to be assembled first, then the diaphragms and finally the wetted path. The following tips will assist in the assembly process.

- Lubricate air valve bore, center section shaft and pilot spool bore with NLGI grade 2 white EP bearing grease or equivalent.
- Clean the inside of the center section shaft bore to ensure no damage is done to new shaft seals.
- A small amount NLGI grade 2 white EP bearing grease can be applied to the muffler and air valve gaskets to locate gaskets during assembly.
- Make sure that the exhaust port on the muffler plate is centered between the two exhaust ports on the center section.
- Stainless bolts should be lubed to reduce the possibility of seizing during tightening.
- Use a mallet to tap lightly on the large clamp bands to seat the diaphragm before tightening.

MAXIMUM TORQUE SPECIFICATIONS

Description of Part	Max. Torque
Air Valve	13.6 N·m (120 in-lbs)
Air Chamber Bolts	27.1 N·m (20 ft-lbs)
Outer Pistons, All	54.2 N·m (40 ft-lbs)
Center Block-to-Stand Bolt	44.7 N·m (33 ft-lbs)
Center Block-to-Bushing Bolt	44.7 N·m (33 ft-lbs)
Locking Pin	44.7 N·m (33 ft-lbs)
Anti-Rotation Bolt	67.8 N·m (50 ft-lbs)



NOTE: To ensure proper alignment during reassembly of manifold/liquid chamber interface, turn off-set portion of valve housing to the left or to the right. This procedure works for the inlet manifold and discharge manifold connections.

SHAFT SEAL INSTALLATION:

PRE-INSTALLATION

- Once all of the old seals have been removed, the inside of the bushing should be cleaned to ensure no debris is left that may cause premature damage to the new seals.

INSTALLATION

The following tools can be used to aid in the installation of the new seals:

- Needle Nose Pliers
- Phillips Screwdriver
- Electrical Tape

- Wrap electrical tape around each leg of the needle nose pliers (heat shrink tubing may also be used). This is done to prevent damaging the inside surface of the new seal.
- With a new seal in hand, place the two legs of the needle nose pliers inside the seal ring. (See Figure A.)
- Open the pliers as wide as the seal diameter will allow, then with two fingers pull down on the top portion of the seal to form kidney bean shape. (See Figure B.)
- Lightly clamp the pliers together to hold the seal into the kidney shape. Be sure to pull the seal into as tight of a kidney shape as possible, this will allow the seal to travel down the bushing bore easier.
- With the seal clamped in the pliers, insert the seal into the bushing bore and position the bottom of the seal into the correct groove. Once the bottom of the seal is seated in the groove, release the clamp pressure on the pliers. This will allow the seal to partially snap back to its original shape.
- After the pliers are removed, you will notice a slight bump in the seal shape. Before the seal can be properly resized, the bump in the seal should be removed as much as possible. This can be done with either the Phillips screwdriver or your finger. With either the side of the screwdriver or your finger, apply light pressure to the peak of the bump. This pressure will cause the bump to be almost completely eliminated.
- Lubricate the edge of the shaft with NLGI grade 2 white EP bearing grease.
- Slowly insert the center shaft with a rotating motion. This will complete the resizing of the seal.
- Perform these steps for the remaining seals.

Figure A

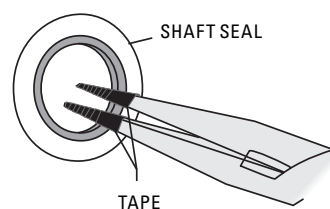
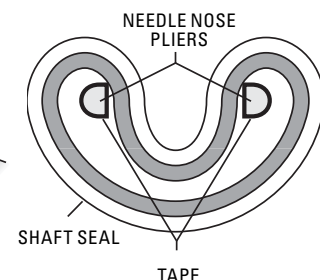

Figure B



The design of the PX8 HS pump allows for ease of cleaning and can be cleaned in place without disassembly. Before any cleaning is attempted, ensure that the cleaning fluids are compatible with all wetted components.

For best cleaning results consider the following information prior to cleaning the PX8 HS pump.

- For best Clean in Place (CIP) results, the pump should be configured to either the EHEDG or 3A configurations.
- Actual CIP effectiveness with pump user's product(s) and processes should be validated on location by the end user's quality assurance personnel to meet internal guidelines. Post cleaning swab test is one method to accomplish this.
- The pump user should establish periodic inspections with full tear down to verify that the CIP processes continue to be effective as first validated.
- Inlet pressure to the pump should not be greater than 0.7 bar 10 (psig). Premature diaphragm failure will occur if greater than 0.7 bar (10 psig) is applied. If the pump is to be subjected to greater than 0.7 bar (10 psig), an optional diaphragm balancing device is suggested to eliminate the possibility of the diaphragms being forced against the air chamber and subsequently causing premature diaphragm failure.

The following are some details to consider when cleaning the PX8 HS pump.

- Through the EHEDG certification process, the PX8 HS pump has been validated to clean equivalent to the inlet tubing of the same diameter. The cleaning chemical supplier should be consulted and advised of this for their chemical solution and application. The same guideline for duration of cleaning cycle and temperature of cleaning fluid apply.

- Suggested flow rate for the PX8 HS pump is 50 gpm/11 m³/hr (usually higher is better).
- Typical CIP temperature is 77 °C to 82 °C (170 °F to 180 °F).
- Typical chemicals include NaOH (sodium hydroxide) caustic for wash and light acid and sanitizers for rinse.
- Once an initial CIP regimen is established, it may need to be modified to accommodate specific process and product differences or requirements. The most common adjustments include:
 - Changing cleaning time (extended or reduced pre-rinse, wash, rinses).
 - Changing cleaning flow rate.
- The cleaning variables are related so that a pump user may be able to reduce the cleaning time by increasing the flow rate or chemical mix.
- Chlorinated sanitizers are known to cause premature failure of stainless steel and should be avoided.

To Clean Pump

- Activate the CIP system while slowly cycling the pump.

NOTE: A typical the CIP temperature limit is 90 °C (195 °F). If the CIP temperature is greater than 90 °C (195 °F), damage to the pump may occur.

EXPLODED VIEW & PARTS LISTING

PX8 SANIFLO[™] HS

EXPLODED VIEW

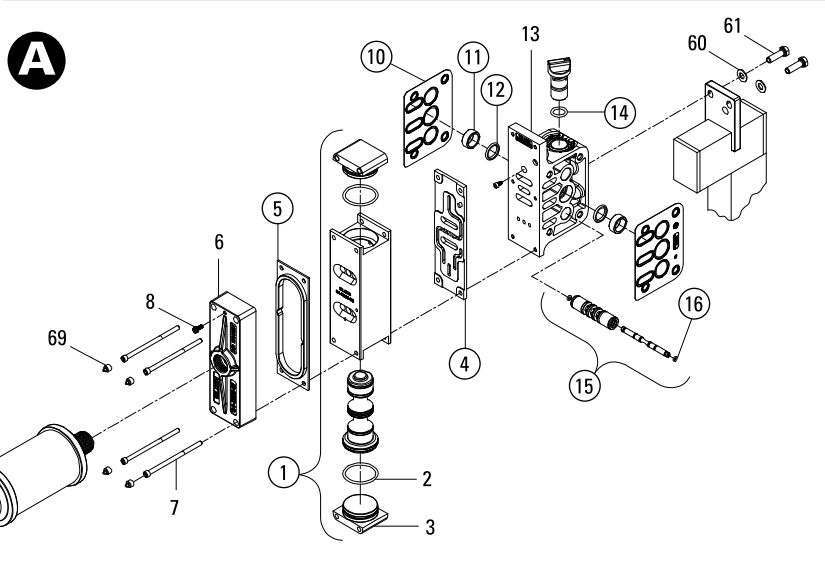
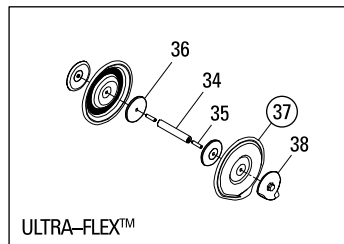
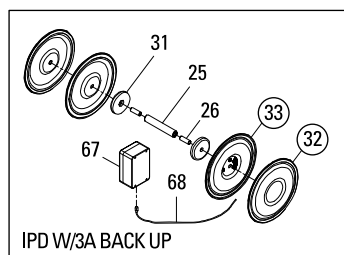
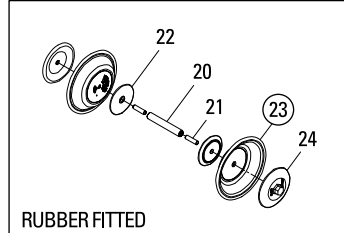
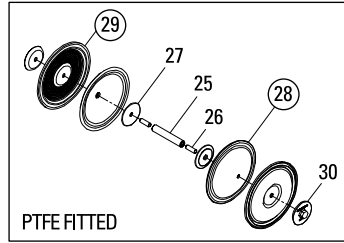
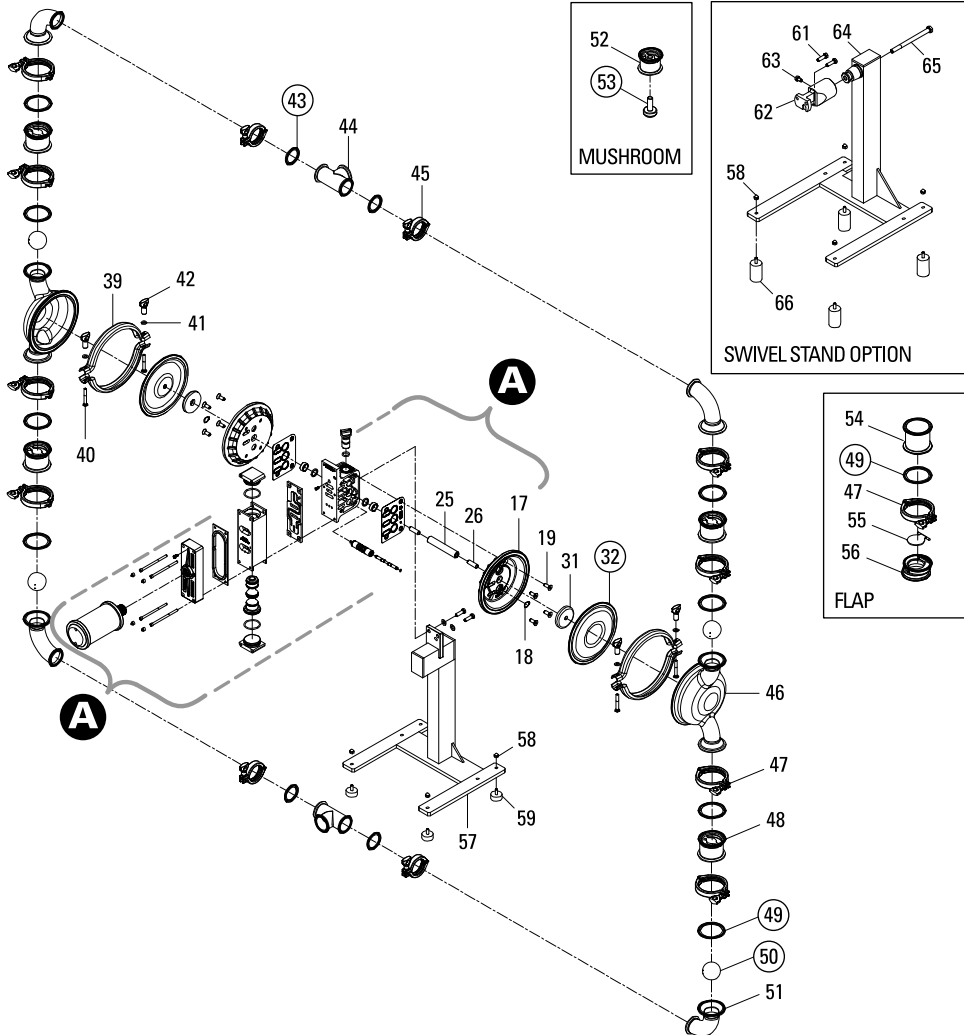



EXPLODED VIEW & PARTS LISTING



PX8 SANIFLO™ HS Nickel Plated ADS

PARTS LISTING

Item	Description	Qty	PX8 HS Rubber Fitted P/N	PX8 HS PTFE Fitted P/N	PX8 HS Ultra-Flex™ Fitted P/N	PX8 EHEDG IPD Fitted P/N	PX8 3A IPD Fitted P/N
1	Air Valve, Pro-Flo V™ ¹	1	04-2030-06	04-2030-06	04-2030-06	04-2030-06	04-2030-06
2	O-Ring (-225), End Cap (Ø1.858" x Ø.139")	2	04-2390-52-700	04-2390-52-700	04-2390-52-700	04-2390-52-700	04-2390-52-700
3	End Cap, Pro-Flo V™	2	04-2340-06	04-2340-06	04-2340-06	04-2340-06	04-2340-06
4	Gasket, Air Valve, Pro-Flo V™	1	04-2620-52	04-2620-52	04-2620-52	04-2620-52	04-2620-52
5	Gasket, Muffler Plate, Pro-Flo V™	1	04-3502-52	04-3502-52	04-3502-52	04-3502-52	04-3502-52
6	Muffler Plate, Pro-Flo V™	1	04-3185-06	04-3185-06	04-3185-06	04-3185-06	04-3185-06
7	Screw, SHC, Air Valve (1/4"-20 X 4.5")	4	01-6000-03	01-6000-03	01-6000-03	01-6000-03	01-6000-03
8	Screw, 10-32 X .50 Self-Tapping Grounding	1	04-6345-08	04-6345-08	04-6345-08	04-6345-08	04-6345-08
9	Sanitary Muffler	1	15-3510-06R	15-3510-06R	15-3510-06R	15-3510-06R	15-3510-06R
10	Gasket, Center Block, Pro-Flo V™	2	04-3529-52	04-3529-52	04-3529-52	04-3529-52	04-3529-52
11	Bushing, Shaft	2	08-3306-13	08-3306-13	08-3306-13	08-3306-13	08-3306-13
12	Shaft Seal	2	08-3210-55-225	08-3210-55-225	08-3210-55-225	08-3210-55-225	08-3210-55-225
13	Center Block, Pro-Flo X™	1	08-3126-06	08-3126-06	08-3126-06	08-3126-06	08-3126-06
14	O-Ring (-210), Adjuster (Ø.734" x Ø.139")	1	02-3200-52	02-3200-52	02-3200-52	02-3200-52	02-3200-52
15	Removable Pilot Sleeve Assembly	1	04-3880-99	04-3880-99	04-3880-99	04-3880-99	04-3880-99
16	Pilot Spool Retaining O-Ring	2	04-2650-49-700	04-2650-49-700	04-2650-49-700	04-2650-49-700	04-2650-49-700
17	Air Chamber, Pro-Flo V™	2	04-3660-06	04-3660-06	04-3660-06	04-3660-06	04-3660-06
18	Retaining Ring	2	04-3890-03	04-3890-03	04-3890-03	04-3890-03	04-3890-03
19	Screw, HSFHS, 3/8"-16 X 1"	8	71-6250-08	71-6250-08	71-6250-08	71-6250-08	71-6250-08
20	Shaft, Pro-Flo™ (Non-PTFE)	1	04-3800-03-700	N/A	N/A	N/A	N/A
21	Shaft Stud, 1/2"-20 X 1 7/8"	2	08-6150-08	N/A	N/A	N/A	N/A
22	Piston, Inner, P4 (Non-PTFE)	2	04-3700-01-700	N/A	N/A	N/A	N/A
▲ 23	Diaphragm, Primary	2	*	N/A	N/A	N/A	N/A
▲ 24	Piston, Outer (Non-PTFE)	2	04-4550-10-385P	N/A	N/A	N/A	N/A
25	Shaft, Pro-Flo™ (PTFE)	1	N/A	04-3820-03-700	N/A	04-3820-03-700	04-3820-03-700
26	Shaft Stud, 1/2"-20 X 1-1/2"	2	N/A	04-6150-08	N/A	04-6150-08	04-6150-08
27	Piston, Inner (PTFE)	2	N/A	04-3752-01	N/A	N/A	N/A
28	Diaphragm, Back-Up	2	N/A	*	N/A	N/A	N/A
▲ 29	Diaphragm, Primary PTFE	2	N/A	04-1010-55	N/A	N/A	N/A
▲ 30	Piston, Outer (PTFE)	2	N/A	04-4600-10-385P	N/A	N/A	N/A
31	Piston, Inner, 1 1/2" EHEDG	2	N/A	N/A	N/A	04-3755-01	04-3755-01
▲ 32	Diaphragm, Integral Piston	2	N/A	N/A	N/A	04-1030-72	04-1030-72
33	Diaphragm, Back-Up, IPD	2	N/A	N/A	N/A	N/A	04-1060-55
34	Shaft, Pro-Flo™ (Ultra-Flex™)	1	N/A	N/A	04-3830-03-700	N/A	N/A
35	Shaft Stud, 3/8"-16 X 1-1/2"	2	N/A	N/A	04-6152-08	N/A	N/A
36	Piston, Inner, P4 (Ultra-Flex™)	2	N/A	N/A	04-3760-01-700	N/A	N/A
▲ 37	Diaphragm, Primary, Ultra-Flex™	2	N/A	N/A	*	N/A	N/A
▲ 38	Piston, Outer (Ultra-Flex™)	2	N/A	N/A	04-4560-10-385P	N/A	N/A
39	Clamp Band Assy. ² Large	2	04-7330-03-385	04-7330-03-385	04-7330-03-385	04-7330-03-385	04-7330-03-385
40	Bolt, RHSN, 5/16"-18 X 2 1/2"	4	04-6070-03	04-6070-03	04-6070-03	04-6070-03	04-6070-03
41	Washer, (Ø.343 X Ø.750 X .05)	4	01-6732-03	01-6732-03	01-6732-03	01-6732-03	01-6732-03
42	Wing Nut, Medium Clamp	4	08-6661-10	08-6661-10	08-6661-10	08-6661-10	08-6661-10
▲ 43	Gasket, 2"	4	*	*	*	*	*
▲ 44	T-Section, 2" EHEDG	2	08-5160-10-385P	08-5160-10-385P	08-5160-10-385P	08-5160-10-385P	08-5160-10-385P
	T-Section, 2" EHEDG DIN	2	08-5160-10-386P	08-5160-10-386P	08-5160-10-386P	N/A	N/A
	T-Section, 2" EHEDG SMS	2	08-5160-10-387P	08-5160-10-387P	08-5160-10-387P	N/A	N/A
45	Clamp Band, Assy, Medium	4	02-7200-03-85	02-7200-03-85	02-7200-03-85	02-7200-03-85	02-7200-03-85
▲ 46	Chamber, Liquid CIP 2" EHEDG	2	08-5000-10-385P	08-5000-10-385P	08-5000-10-385P	08-5000-10-385P	08-5000-10-385P
47	Clamp Band ASSY, 3"	8	15-7102-03	15-7102-03	15-7102-03	15-7102-03	15-7102-03
▲ 48	Ball Cage, 2" EHEDG	4	08-5350-10-385P	08-5350-10-385P	08-5350-10-385P	08-5350-10-385P	08-5350-10-385P
▲ 49	Gasket, 3"	8	*	*	*	*	*
▲ 50	Valve Ball	4	*	*	*	*	*
▲ 51	Elbow, 2" EHEDG	4	08-5240-10-385P	08-5240-10-385P	08-5240-10-385P	08-5240-10-385P	08-5240-10-385P
▲ 52	Mushroom Valve Housing	4	08-5431-10-385P	08-5431-10-385P	08-5431-10-385P	N/A	N/A
▲ 53	Mushroom Valve	4	08-1096-55	08-1096-55	08-1096-55	N/A	N/A
▲ 54	Flap Valve Spacer 2"	4	08-5285-10-83P	08-5285-10-83P	08-5285-10-83P	N/A	N/A
▲ 55	Flap Valve 2"	4	08-1180-10-83P	08-1180-10-83P	08-1180-10-83P	N/A	N/A
▲ 56	Flap Valve Body 2"	4	08-5280-10-83P	08-5280-10-83P	08-5280-10-83P	N/A	N/A
57	Stand, Pump, PV Assy. ³	1	08-7652-03	08-7652-03	08-7652-03	08-7652-03	N/A
58	Nut, Cap, 5/16"-18, Pump Stand	4	08-6600-03-72	08-6600-03-72	08-6600-03-72	08-6600-03-72	08-6600-03-72
59	Pad, Pump Stand	4	08-7670-20	08-7670-20	08-7670-20	N/A	N/A
60	Washer, Flat (Ø.406 X Ø.812 X .065)	2	04-6740-03	04-6740-03	04-6740-03	04-6740-03	N/A
61	Screw, HHC, 3/8"-16 X 1-1/4"	2	04-6190-03	04-6190-03	04-6190-03	04-6190-03	04-6190-03
62	Bushing, Center Block Mounting	1	15-7665-03	15-7665-03	15-7665-03	15-7665-03	15-7665-03
63	Locking Pin	1	08-7694-03	08-7694-03	08-7694-03	08-7694-03	08-7694-03
64	Pump Stand, Swivel, Assy. ⁴ (3-A)	1	08-7655-03	08-7655-03	08-7655-03	08-7655-03	08-7655-03
65	Screw, HHC, 1/2"-13 X 6"	1	15-6143-03	15-6143-03	15-6143-03	15-6143-03	15-6143-03
66	Pad, Pump Stand 2" (3-A)	4	N/A	N/A	N/A	N/A	08-7672-20
67	Control Module, Wil-Gard II, 110 (3-A)	1	N/A	N/A	N/A	N/A	65-8001-99
68	Sensor Cables, Wil-Gard II (3-A)	1	N/A	N/A	N/A	N/A	65-8020-99
69	Plug, 1/4" SHCS (3-A)	4	N/A	N/A	N/A	N/A	02-7825-17

*Refer to Elastomer Chart

¹Includes: items 2 and 3.

³Includes: items 58 and 59.

All boldface items are primary wear parts.

▲ Product Contact Components

²Includes: items 40, 41 and 42.

⁴Includes: items 58, 62, 63, 65 and 66.

PX8 SANIFLO™ HS

Stainless Steel ADS

PARTS LISTING

Item	Description	Qty	PX8 HS Rubber Fitted P/N	PX8 HS PTFE Fitted P/N	PX8 HS Ultra-Flex™ Fitted P/N	PX8 EHEDG IPD Fitted P/N	PX8 3A IPD Fitted P/N
1	Air Valve, Pro-Flo V™ ¹	1	04-2030-03	04-2030-03	04-2030-03	04-2030-03	04-2030-03
2	O-Ring (-225), End Cap (Ø1.858" x Ø.139")	2	04-2390-52-700	04-2390-52-700	04-2390-52-700	04-2390-52-700	04-2390-52-700
3	End Cap, Pro-Flo V™	2	04-2340-03	04-2340-03	04-2340-03	04-2340-03	04-2340-03
4	Gasket, Air Valve, Pro-Flo V™	1	04-2620-52	04-2620-52	04-2620-52	04-2620-52	04-2620-52
5	Gasket, Muffler Plate, Pro-Flo V™	1	04-3502-52	04-3502-52	04-3502-52	04-3502-52	04-3502-52
6	Muffler Plate, Pro-Flo V™	1	04-3185-03	04-3185-03	04-3185-03	04-3185-03	04-3185-03
7	Screw, SHC, Air Valve (1/4"-20 X 4.5")	4	01-6000-03	01-6000-03	01-6000-03	01-6000-03	01-6000-03
8	Screw, 10-32 X .50 Self-Tapping Grounding	1	04-6345-08	04-6345-08	04-6345-08	04-6345-08	04-6345-08
9	Sanitary Muffler	1	15-3510-06R	15-3510-06R	15-3510-06R	15-3510-06R	15-3510-06R
10	Gasket, Center Block, Pro-Flo V™	2	04-3529-52	04-3529-52	04-3529-52	04-3529-52	04-3529-52
11	Bushing, Shaft	2	08-3306-13	08-3306-13	08-3306-13	08-3306-13	08-3306-13
12	Shaft Seal	2	08-3210-55-225	08-3210-55-225	08-3210-55-225	08-3210-55-225	08-3210-55-225
13	Center Block, Pro-Flo X™	1	08-3126-03	08-3126-03	08-3126-03	08-3126-03	08-3126-03
14	O-Ring (-210), Adjuster (Ø.734" x Ø.139")	1	02-3200-52	02-3200-52	02-3200-52	02-3200-52	02-3200-52
15	Removable Pilot Sleeve Assembly	1	04-3880-99	04-3880-99	04-3880-99	04-3880-99	04-3880-99
16	Pilot Spool Retaining O-Ring	2	04-2650-49-700	04-2650-49-700	04-2650-49-700	04-2650-49-700	04-2650-49-700
17	Air Chamber, Pro-Flo V™	2	04-3660-03	04-3660-03	04-3660-03	04-3660-03	04-3660-03
18	Retaining Ring	2	04-3890-03	04-3890-03	04-3890-03	04-3890-03	04-3890-03
19	Screw, HSFHS, 3/8"-16 X 1"	8	71-6250-08	71-6250-08	71-6250-08	71-6250-08	71-6250-08
20	Shaft, Pro-Flo™, Non-PTFE	1	04-3800-03-700	N/A	N/A	N/A	N/A
21	Shaft Stud, 1/2"-20 X 1 7/8"	2	08-6150-08	N/A	N/A	N/A	N/A
22	Piston, Inner, P4 (Non-PTFE)	2	04-3700-01-700	N/A	N/A	N/A	N/A
▲ 23	Diaphragm, Primary	2	*	N/A	N/A	N/A	N/A
▲ 24	Piston, Outer (Non-PTFE)	2	04-4550-10-385P	N/A	N/A	N/A	N/A
25	Shaft, Pro-Flo™ (PTFE)	1	N/A	04-3820-03-700	N/A	04-3820-03-700	04-3820-03-700
26	Shaft Stud, 1/2"-20 X 1-1/2"	2	N/A	04-6150-08	N/A	04-6150-08	04-6150-08
27	Piston, Inner (PTFE)	2	N/A	04-3752-01	N/A	N/A	N/A
28	Diaphragm, Back-Up	2	N/A	*	N/A	N/A	N/A
▲ 29	Diaphragm, Primary PTFE	2	N/A	04-1010-55	N/A	N/A	N/A
▲ 30	Piston, Outer (PTFE)	2	N/A	04-4600-10-385P	N/A	N/A	N/A
31	Piston, Inner, 1 1/2" EHEDG	2	N/A	N/A	N/A	04-3755-01	04-3755-01
▲ 32	Diaphragm, Integral Piston	2	N/A	N/A	N/A	04-1030-72	04-1030-72
33	Diaphragm, Back-Up, IPD	2	N/A	N/A	N/A	N/A	04-1060-55
34	Shaft, Pro-Flo™ (Ultra-Flex™)	1	N/A	N/A	04-3830-03-700	N/A	N/A
35	Shaft Stud, 3/8"-16 X 1-1/2"	2	N/A	N/A	04-6152-08	N/A	N/A
36	Piston, Inner, P4 (Ultra-Flex™)	2	N/A	N/A	04-3760-01-700	N/A	N/A
▲ 37	Diaphragm, Primary, Ultra-Flex™	2	N/A	N/A	*	N/A	N/A
▲ 38	Piston, Outer, Ultra-Flex™	2	N/A	N/A	04-4560-10-385P	N/A	N/A
39	Clamp Band Assy. ² Large	2	04-7330-03-385	04-7330-03-385	04-7330-03-385	04-7330-03-385	04-7330-03-385
40	Bolt, RHSN, 5/16"-18 X 2 1/2"	4	04-6070-03	04-6070-03	04-6070-03	04-6070-03	04-6070-03
41	Washer, (Ø.343 X Ø.750 X .05)	4	01-6732-03	01-6732-03	01-6732-03	01-6732-03	01-6732-03
42	Wing Nut, Medium Clamp	4	08-6661-10	08-6661-10	08-6661-10	08-6661-10	08-6661-10
▲ 43	Gasket, 2"	4	*	*	*	*	*
▲ 44	T-Section, 2" EHEDG	2	08-5160-10-385P	08-5160-10-385P	08-5160-10-385P	08-5160-10-385P	08-5160-10-385P
	T-Section, 2" EHEDG DIN	2	08-5160-10-386P	08-5160-10-386P	08-5160-10-386P	N/A	N/A
	T-Section, 2" EHEDG SMS	2	08-5160-10-387P	08-5160-10-387P	08-5160-10-387P	N/A	N/A
45	Clamp Band, Assy, Medium	4	02-7200-03-85	02-7200-03-85	02-7200-03-85	02-7200-03-85	02-7200-03-85
▲ 46	Chamber, Liquid CIP 2" EHEDG	2	08-5000-10-385P	08-5000-10-385P	08-5000-10-385P	08-5000-10-385P	08-5000-10-385P
47	Clamp Band ASSY, 3"	8	15-7102-03	15-7102-03	15-7102-03	15-7102-03	15-7102-03
▲ 48	Ball Cage, 2" EHEDG	4	08-5350-10-385P	08-5350-10-385P	08-5350-10-385P	08-5350-10-385P	08-5350-10-385P
▲ 49	Gasket, 3"	8	*	*	*	*	*
▲ 50	Valve Ball	4	*	*	*	*	*
▲ 51	Elbow, 2" EHEDG	4	08-5240-10-385P	08-5240-10-385P	08-5240-10-385P	08-5240-10-385P	08-5240-10-385P
▲ 52	Mushroom Valve Housing	4	08-5431-10-385P	08-5431-10-385P	08-5431-10-385P	N/A	N/A
▲ 53	Mushroom Valve	4	08-1096-55	08-1096-55	08-1096-55	N/A	N/A
▲ 54	Flap Valve Spacer 2"	4	08-5285-10-83P	08-5285-10-83P	08-5285-10-83P	N/A	N/A
▲ 55	Flap Valve 2"	4	08-1180-10-83P	08-1180-10-83P	08-1180-10-83P	N/A	N/A
▲ 56	Flap Valve Body 2"	4	08-5280-10-83P	08-5280-10-83P	08-5280-10-83P	N/A	N/A
57	Stand, Pump, PV Assy. ³	1	08-7652-03	08-7652-03	08-7652-03	08-7652-03	N/A
58	Nut, Cap, 5/16"-18, Pump Stand	4	08-6600-03-72	08-6600-03-72	08-6600-03-72	08-6600-03-72	08-6600-03-72
59	Pad, Pump Stand	4	08-7670-20	08-7670-20	08-7670-20	08-7670-20	N/A
60	Washer, Flat (Ø.406 X Ø.812 X .065)	2	04-6740-03	04-6740-03	04-6740-03	04-6740-03	N/A
61	Screw, HHC, 3/8"-16 X 1-1/4"	2	04-6190-03	04-6190-03	04-6190-03	04-6190-03	04-6190-03
62	Bushing, Center Block Mounting	1	15-7665-03	15-7665-03	15-7665-03	15-7665-03	15-7665-03
63	Locking Pin	1	08-7694-03	08-7694-03	08-7694-03	08-7694-03	08-7694-03
64	Pump Stand, Swivel, Assy. ⁴ (3-A)	1	08-7655-03	08-7655-03	08-7655-03	08-7655-03	08-7655-03
65	Screw, HHC, 1/2"-13 X 6"	1	15-6143-03	15-6143-03	15-6143-03	15-6143-03	15-6143-03
66	Pad, Pump Stand 2" (3-A)	4	N/A	N/A	N/A	N/A	08-7672-20
67	Control Module, Wil-Gard II, 110 (3-A)	1	N/A	N/A	N/A	N/A	65-8001-99
68	Sensor Cables, Wil-Gard II (3-A)	1	N/A	N/A	N/A	N/A	65-8020-99
69	Plug, 1/4" SHCS (3-A)	4	N/A	N/A	N/A	N/A	02-7825-17

*Refer to Elastomer Chart

¹Includes: items 2 and 3.

³Includes: items 58 and 59.

All boldface items are primary wear parts.

▲ Product Contact Components

²Includes: items 40, 41 and 42.

⁴Includes: items 58, 62, 63, 65 and 66.



ELASTOMER OPTIONS

PX8 SANIFLO™ HS

MATERIAL	DIAPHRAGMS (Color Code)	BACK UP DIAPHRAGMS (Color Code)	ULTRA-FLEX™ DIAPHRAGMS (Color Code)	VALVE BALL (Color Code)	GASKET, 2" (Color Code)	GASKET, 3" (Color Code)
FDA BUNA-N	04-1010-69 (2 yellow dots)	N/A	04-1020-52 (red dot)	08-1086-69 (2 yellow dots)	08-1375-69 (red dot)	15-1375-69 (red dot)
FDA EPDM	04-1010-74 (2 blue dots)	04-1060-54 (blue dot)	04-1020-54 (blue dot)	08-1086-74 (2 blue dots)	08-1375-74 (green dot)	15-1375-74 (green dot)
SANIFLEX™	04-1010-56 (cream)	04-1060-56 (cream)	N/A	08-1086-56 (cream)	N/A	N/A
TEFLON® PTFE	**	N/A	N/A	08-1086-55 (white)	08-1375-55 (white)	15-1375-55 (white)
FDA WIL-FLEX™	04-1010-57 (2 orange dots)	N/A	N/A	08-1086-57 (2 orange dots)	N/A	N/A
FDA VITON®	N/A	N/A	N/A	N/A	02-1400-68-85 (white/yellow)	15-1375-68 (white/yellow)

**See BOM Chart

▲ Product Contact Components

Initially Issued: 6/22/1995

Authorization No.: 833



This Is To Certify That

Wilden Pump & Engineering LLC
22069 Van Buren Street, Grand Terrace, CA 92313-5651

Is hereby authorized to continue to apply the 3-A Symbol to the models of equipment, conforming to 3-A Sanitary Standards for:

Diaphragm Pumps, Number: 44-03, set forth below:

Model Designations: See Attached List

Valid through: December 31, 2010

Timothy R. Rugh

Executive Director, 3-A Sanitary Standards, Inc.

The issuance of this authorization for the use of the 3-A Symbol is based upon the voluntary certification, by the applicant for it, that the equipment listed above complies fully with the 3-A Sanitary Standards designated. Legal responsibility for compliance is solely that of the holder of this Certificate of Authorization, and 3-A Sanitary Standards, Inc. does not warrant that the holder of an authorization at all times complies with the provisions of the said 3-A Sanitary Standards. This in no way affects the responsibility of 3-A Sanitary Standards, Inc. to take appropriate action in such cases in which evidence of nonconformance has been established.

Next TPV Inspection/Report due: January 2014

CERTIFICATE OF COMPLIANCE

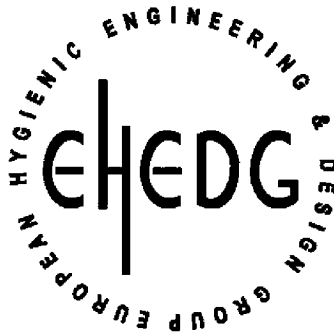

TNO Certification
hereby declares that the product

Air operated double Diaphragm Pump type Saniflo HS size 1.0" to 3.0"

From

Wilden Pump & Engineering, LLC, Grand Terrace, USA

has been evaluated for compliance with the Hygienic Equipment Design Criteria
of the EHEDG, Document No. 8, by:

TNO Quality of Life at Zeist, Netherlands
and meets the criteria of this document as demonstrated by:

Evaluation Report No. V6621RE

Signed  _____
Evaluation Officer

Date June 15, 2006

Signed  _____
Managing Director, TNO Certification

Date June 15, 2006



Certificate No. C06-8337

TNO Certification BV, P.O. Box 541, 7300 AM Apeldoorn, Netherlands
©EHEDG

WARRANTY

Each and every product manufactured by Wilden Pump and Engineering, LLC is built to meet the highest standards of quality. Every pump is functionally tested to insure integrity of operation.

Wilden Pump and Engineering, LLC warrants that pumps, accessories and parts manufactured or supplied by it to be free from defects in material and workmanship for a period of five (5) years from date of installation or six (6) years from date of manufacture, whichever comes first. Failure due to normal wear, misapplication, or abuse is, of course, excluded from this warranty.

Since the use of Wilden pumps and parts is beyond our control, we cannot guarantee the suitability of any pump or part for a particular application and Wilden Pump and Engineering, LLC shall not be liable for any consequential damage or expense arising from the use or misuse of its products on any application. Responsibility is limited solely to replacement or repair of defective Wilden pumps and parts.

All decisions as to the cause of failure are the sole determination of Wilden Pump and Engineering, LLC.

Prior approval must be obtained from Wilden for return of any items for warranty consideration and must be accompanied by the appropriate MSDS for the product(s) involved. A Return Goods Tag, obtained from an authorized Wilden distributor, must be included with the items which must be shipped freight prepaid.

The foregoing warranty is exclusive and in lieu of all other warranties expressed or implied (whether written or oral) including all implied warranties of merchantability and fitness for any particular purpose. No distributor or other person is authorized to assume any liability or obligation for Wilden Pump and Engineering, LLC other than expressly provided herein.

PLEASE PRINT OR TYPE AND FAX TO WILDEN

PUMP INFORMATION			
Item # _____		Serial # _____	
Company Where Purchased _____			
YOUR INFORMATION			
Company Name _____			
Industry _____			
Name _____		Title _____	
Street Address _____			
City _____		State _____	Country _____
Telephone _____		Fax _____	Web Address _____
Number of pumps in facility? _____		Number of Wilden pumps? _____	
Types of pumps in facility (check all that apply): <input type="checkbox"/> Diaphragm <input type="checkbox"/> Centrifugal <input type="checkbox"/> Gear <input type="checkbox"/> Submersible <input type="checkbox"/> Lobe			
<input type="checkbox"/> Other _____			
Media being pumped? _____			
How did you hear of Wilden Pump? <input type="checkbox"/> Trade Journal <input type="checkbox"/> Trade Show <input type="checkbox"/> Internet/E-mail <input type="checkbox"/> Distributor			
<input type="checkbox"/> Other _____			

ONCE COMPLETE, FAX TO (909) 783-3440

NOTE: WARRANTY VOID IF PAGE IS NOT FAXED TO WILDEN
WILDEN PUMP & ENGINEERING, LLC